

Thomas&Betts

**EMERGENCY BALLAST
WIRING GUIDE**

rev. 103103



HOW TO USE THE EMERGENCY BALLAST WIRING GUIDE

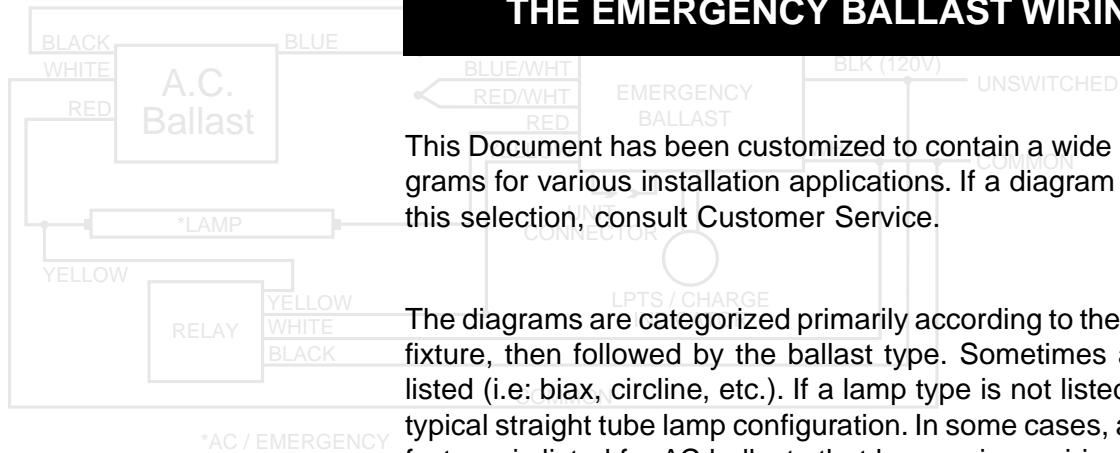

This Document has been customized to contain a wide library of individual diagrams for various installation applications. If a diagram cannot be found within this selection, consult Customer Service.

The diagrams are categorized primarily according to the number of lamps in the fixture, then followed by the ballast type. Sometimes a specific lamp type is listed (i.e: biax, circline, etc.). If a lamp type is not listed, the diagram shows a typical straight tube lamp configuration. In some cases, a specific ballast manufacturer is listed for AC ballasts that have unique wiring arrangements.

Diagrams for specific situations can be located within this PDF file by using the following methods:

1) USING THE NAVIGATION WINDOW

Use the Navigation window and select the Emergency Ballast for which the diagram is needed, then scroll through the list of applications to find the diagram(s) that meet the necessary criteria by clicking on the “plus” sign next to the Unit Model. (Many of the diagrams are bookmarked with identical descriptions. Examine the diagram for details as to whether or not it applies to your situation.)

NOTE: The order in which the pages are bookmarked is not indicative of the actual page order, therefore, continuing to the next page after a “Two Lamp Ballast” diagram may not necessarily take you to another “Two Lamp Ballast” diagram. To aid in locating specific diagrams, each has been bookmarked and categorized in the navigation window.

2) USING THE FIND COMMAND

Some diagrams feature a Model List for reference. If you know the actual model number of the AC ballast that the emergency unit is being wired to, you may use the “FIND” tool in the toolbar (Denoted by the binocular icon) to search the diagrams for that particular model. FIND commands may or may not be successful, since not all ballasts models are listed within this file.

When using the FIND command, it may be helpful to search for only the first few letters or numbers of the model number (i.e. “RCN” or “ECO”) due to the nature of how the reference lists are compiled. Include any hyphens or slashes that may appear in the model number when using the FIND command.

This Guide is by no means an exhaustive record of all AC Ballast/Emergency Unit combinations. If a search using the FIND command or Navigation window is not successful, contact Customer Service for further assistance.

You may request an updated Wiring Diagram Guide at anytime. Please consult Customer Service to find out if a later version with any additions and/or corrections is available.

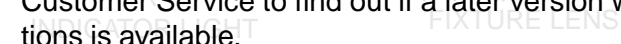
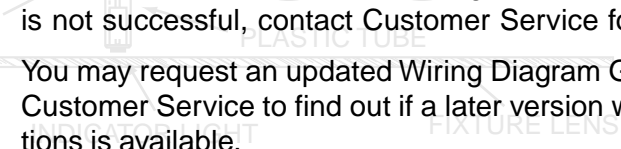
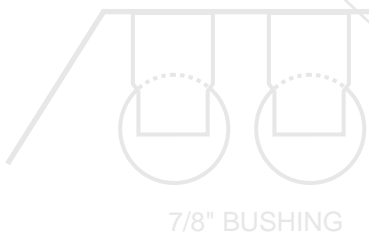
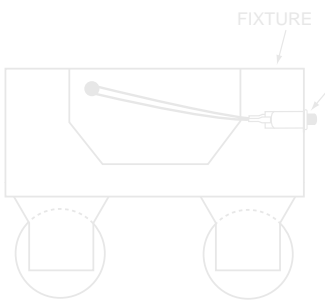
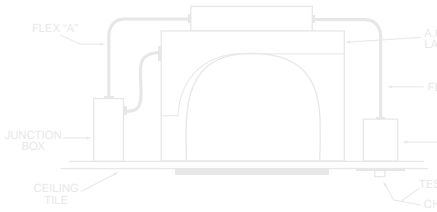

ONE LAMP INSTANT START BALLAST

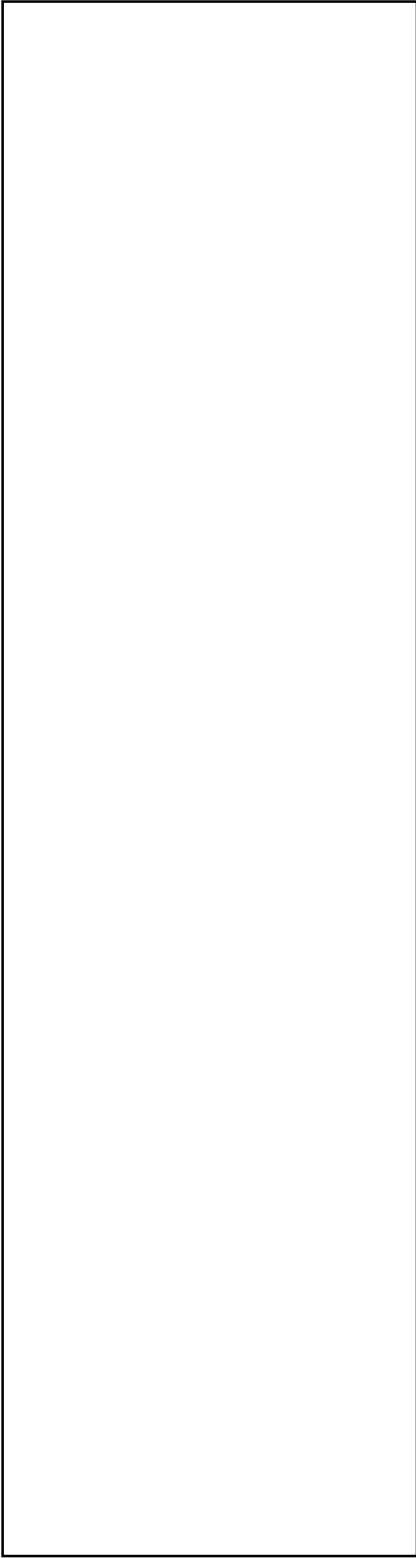
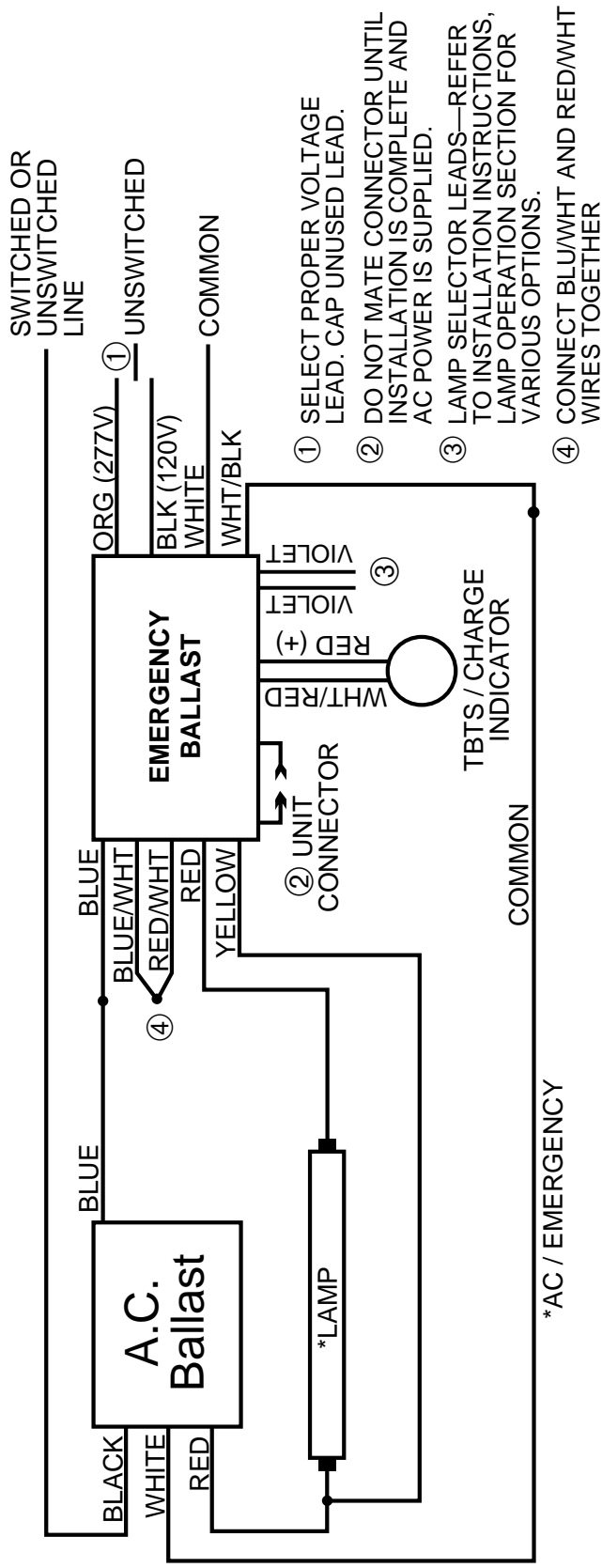

ONE LAMP RAPID START BALLAST

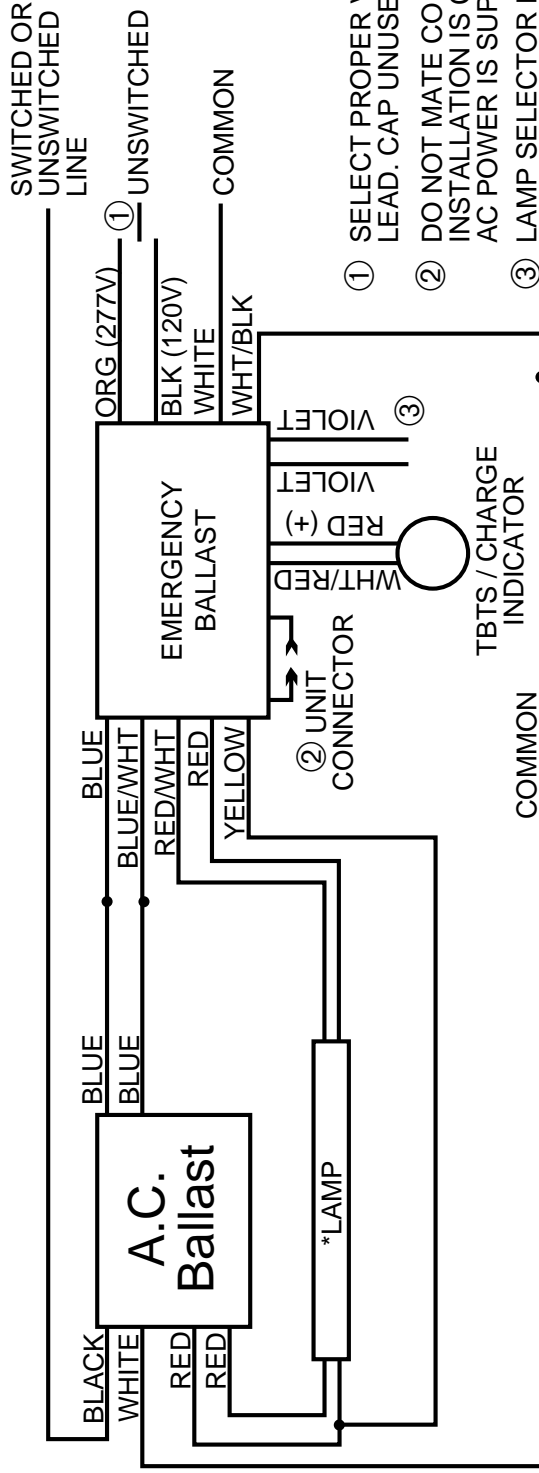

- ① SELECT PROPER VOLTAGE LEAD. CAP UNUSED LEAD.
- ② DO NOT MATE CONNECTOR UNTIL INSTALLATION IS COMPLETE AND AC POWER IS SUPPLIED.
- ③ LAMP SELECTOR LEADS—REFER TO INSTALLATION INSTRUCTIONS, LAMPS OPERATION SECTION FOR VARIOUS OPTIONS

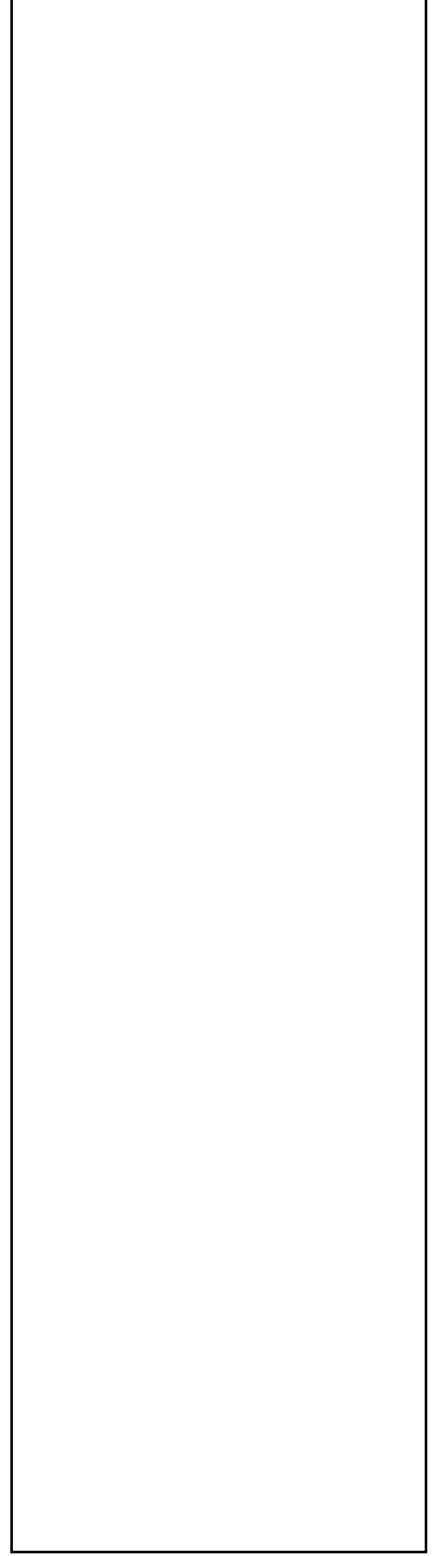

ONE LAMP RAPID START BALLAST

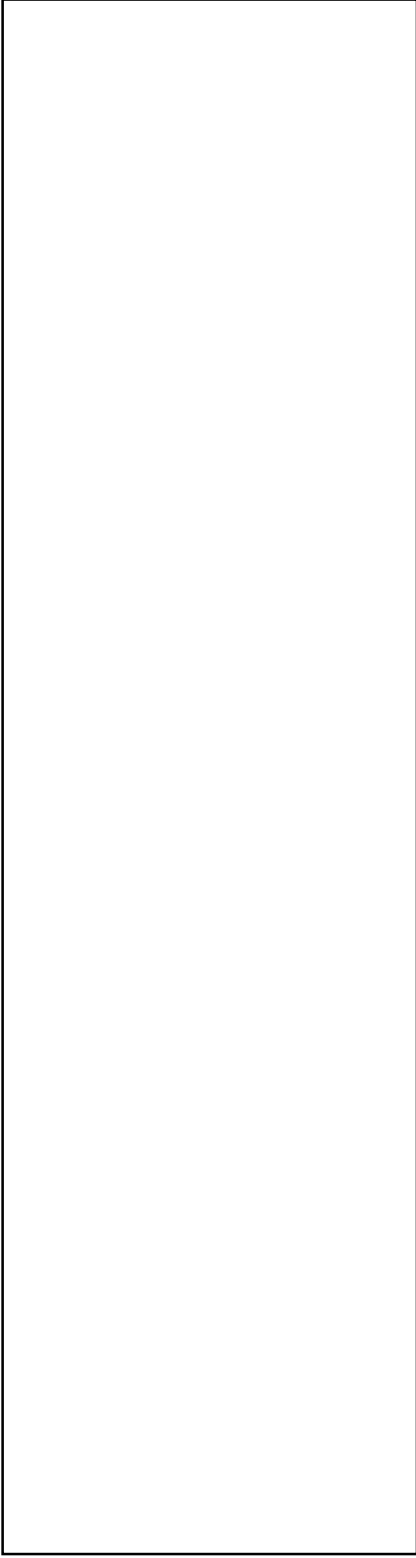
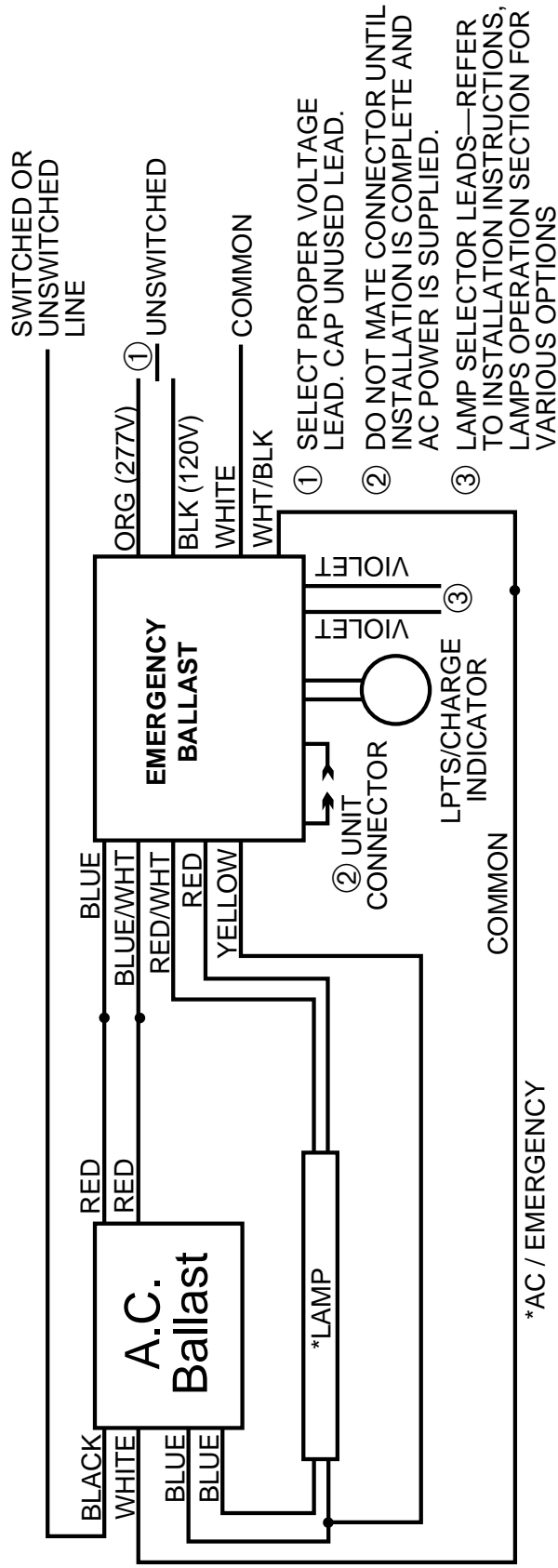

TWO LAMP INSTANT START BALLAST

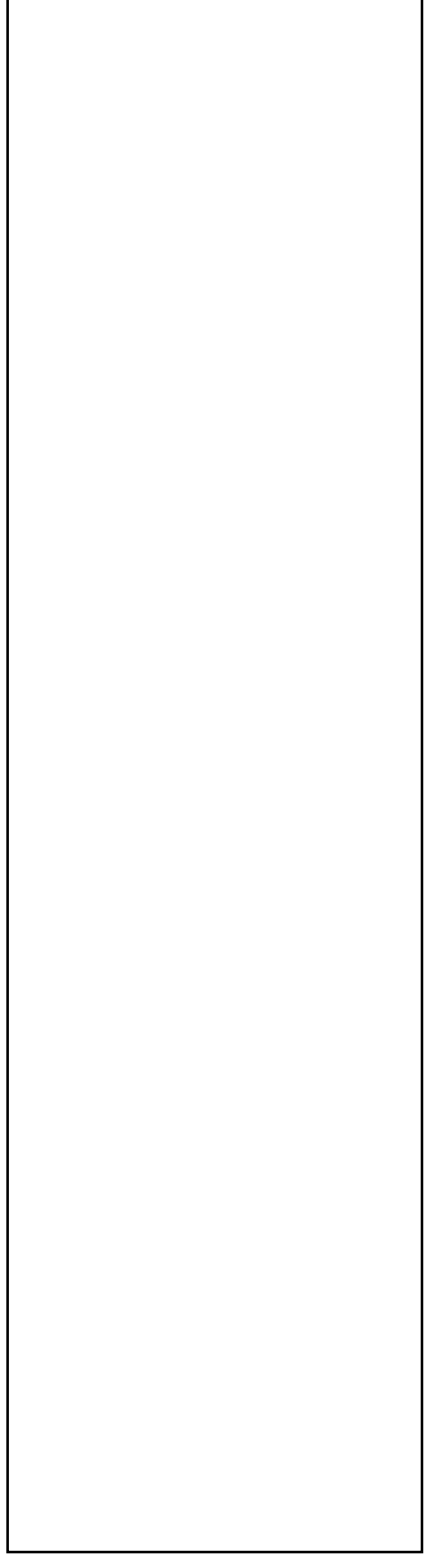
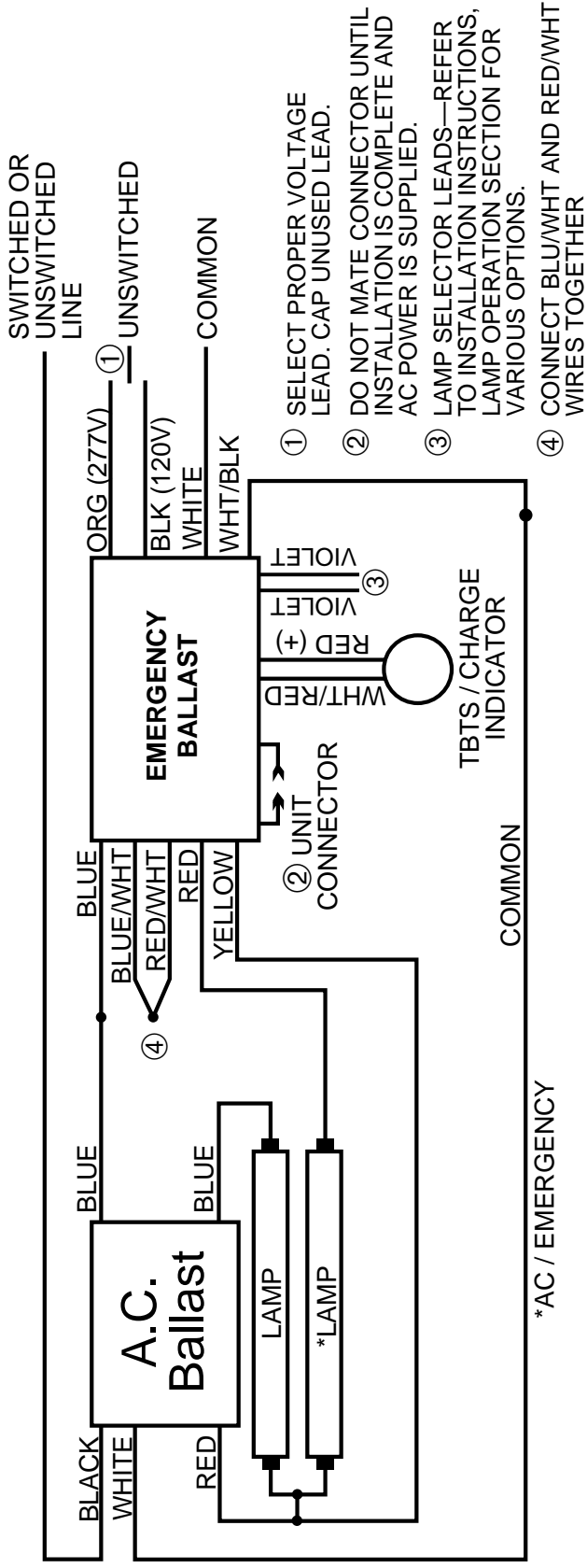

TWO LAMP INSTANT START BALLAST WITH TWO LAMP EMERGENCY OPERATION

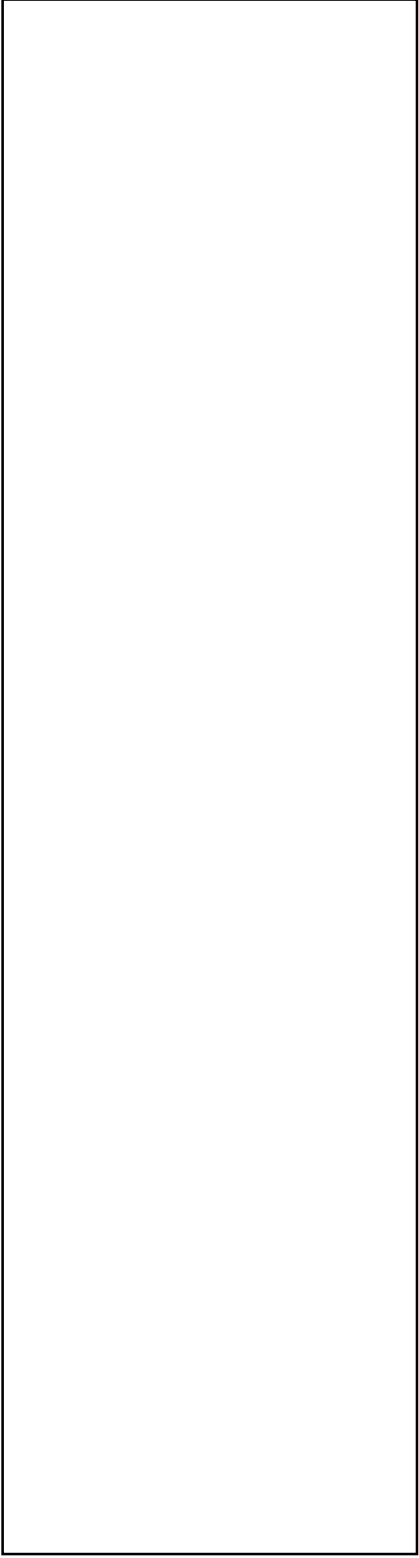
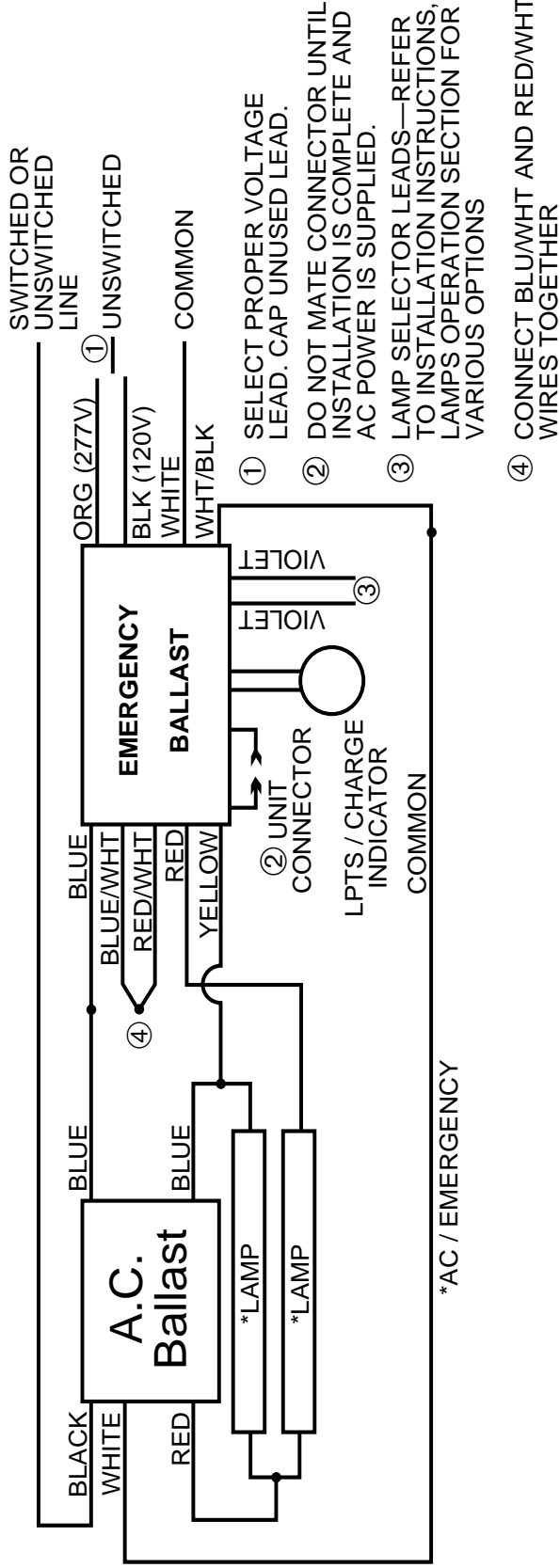

TWO LAMP RAPID START BALLAST WITH TWO LAMP EMERGENCY OPERATION

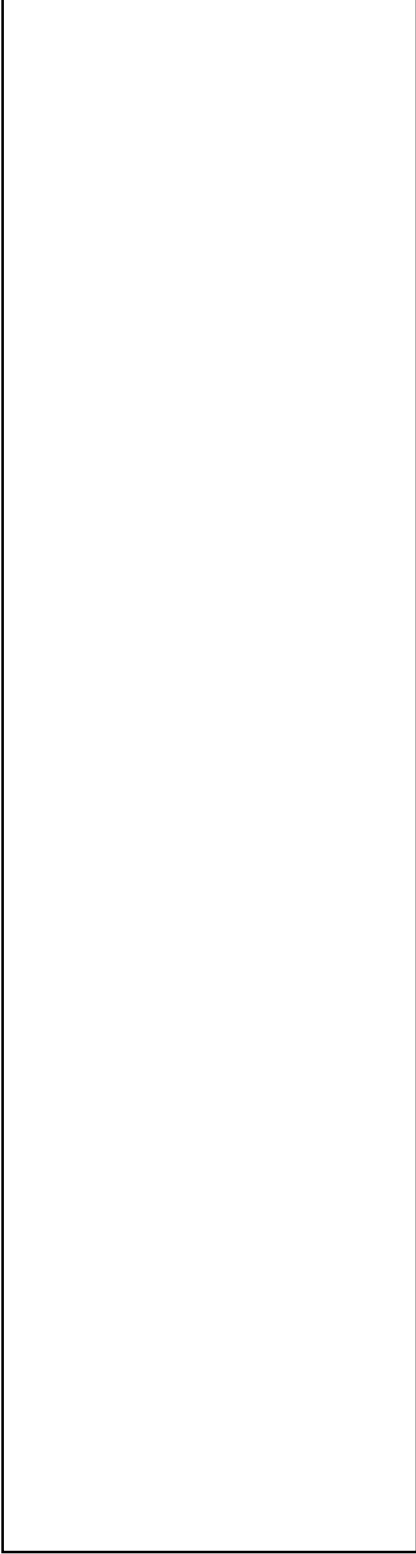
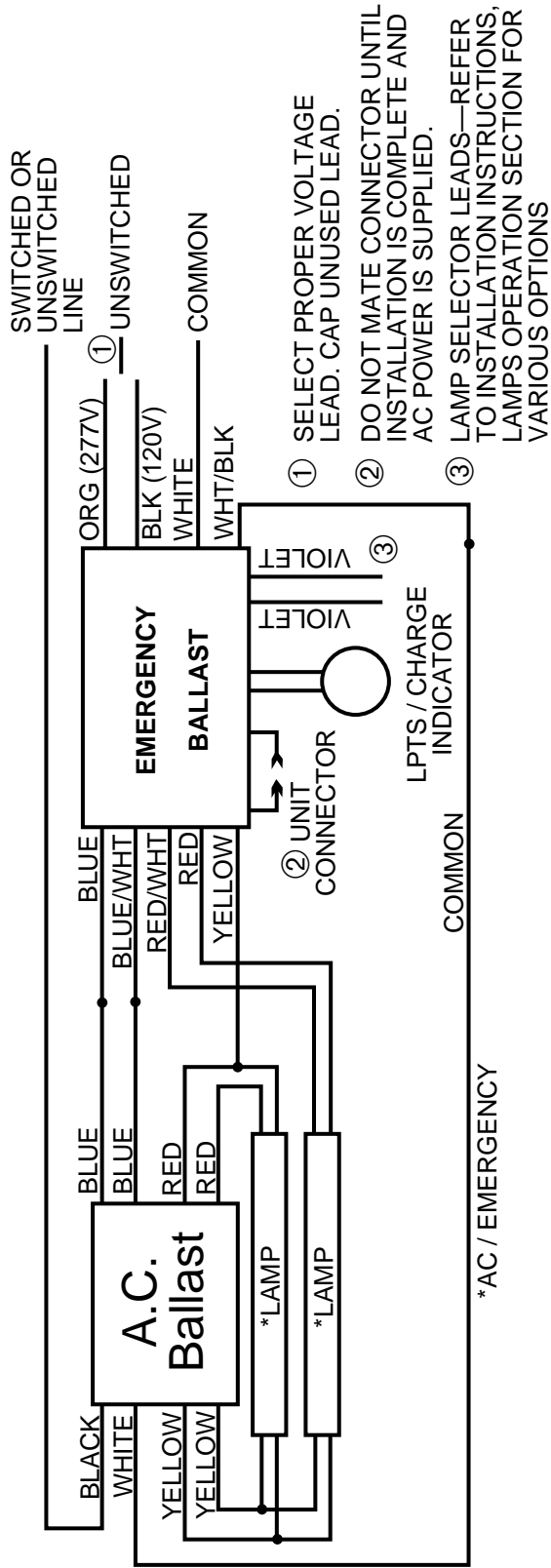

TWO LAMP RAPID START BALLAST WITH TWO LAMP EMERGENCY OPERATION

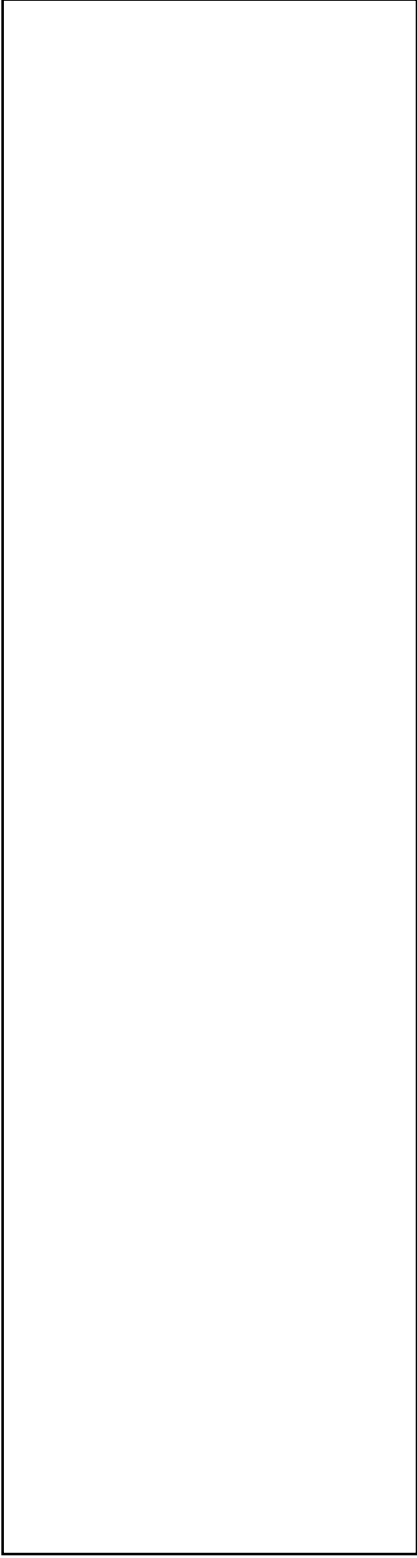
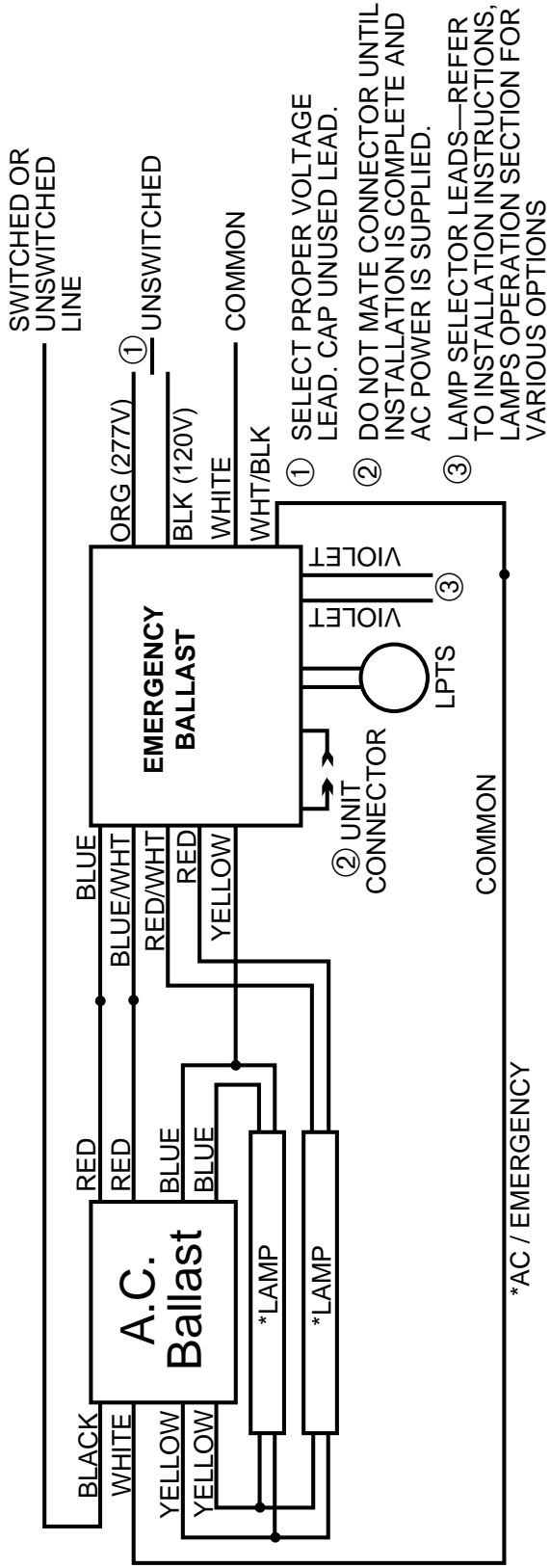

TWO LAMP RAPID START BALLAST

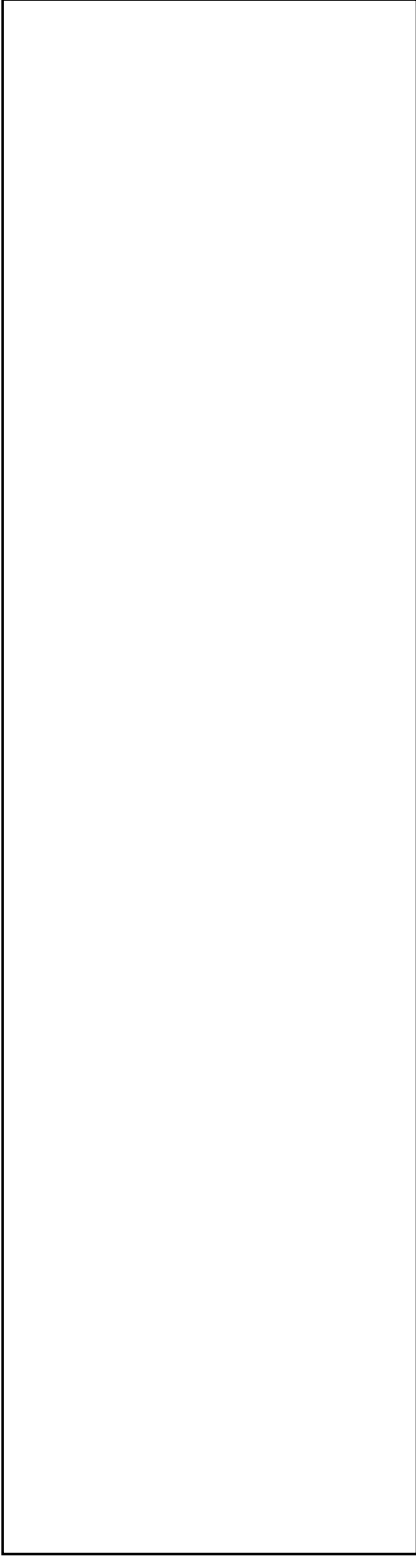
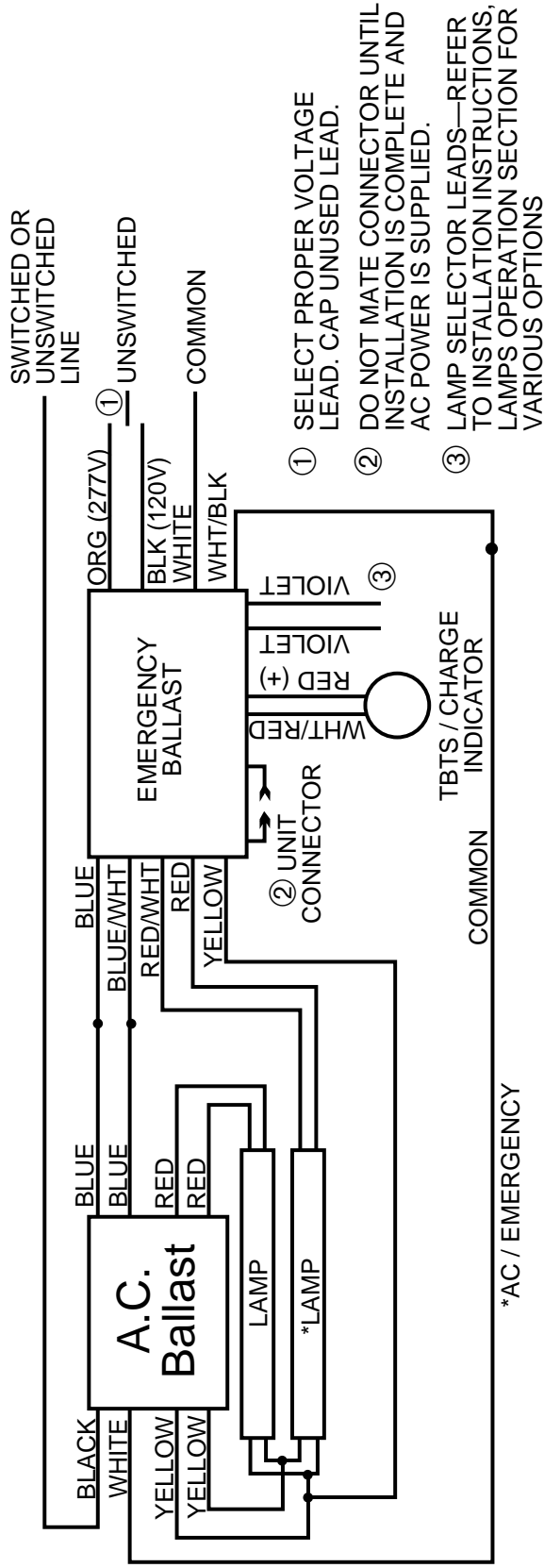

TWO LAMP RAPID START BALLAST

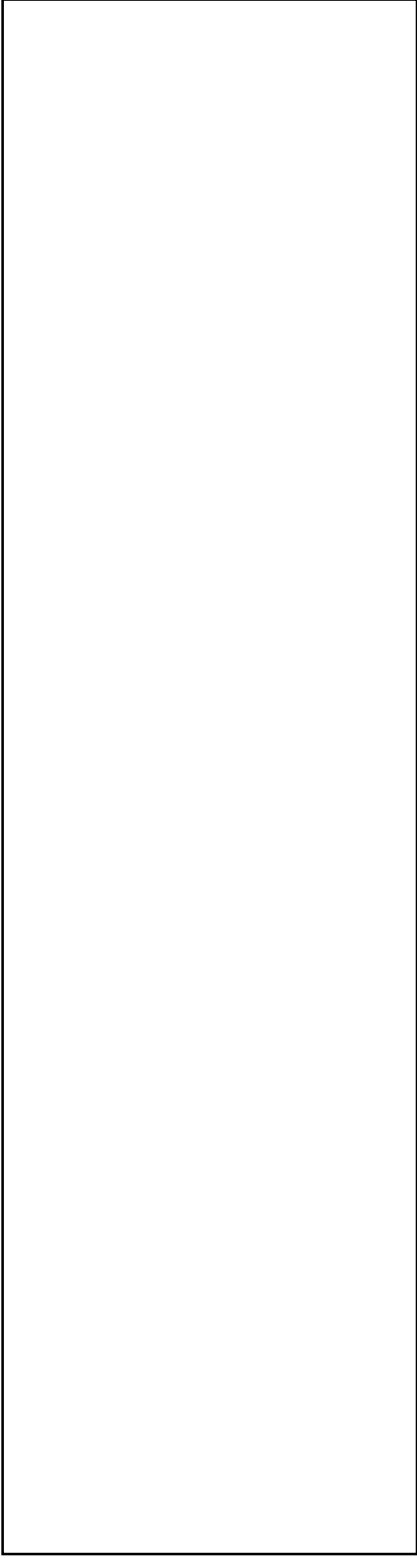
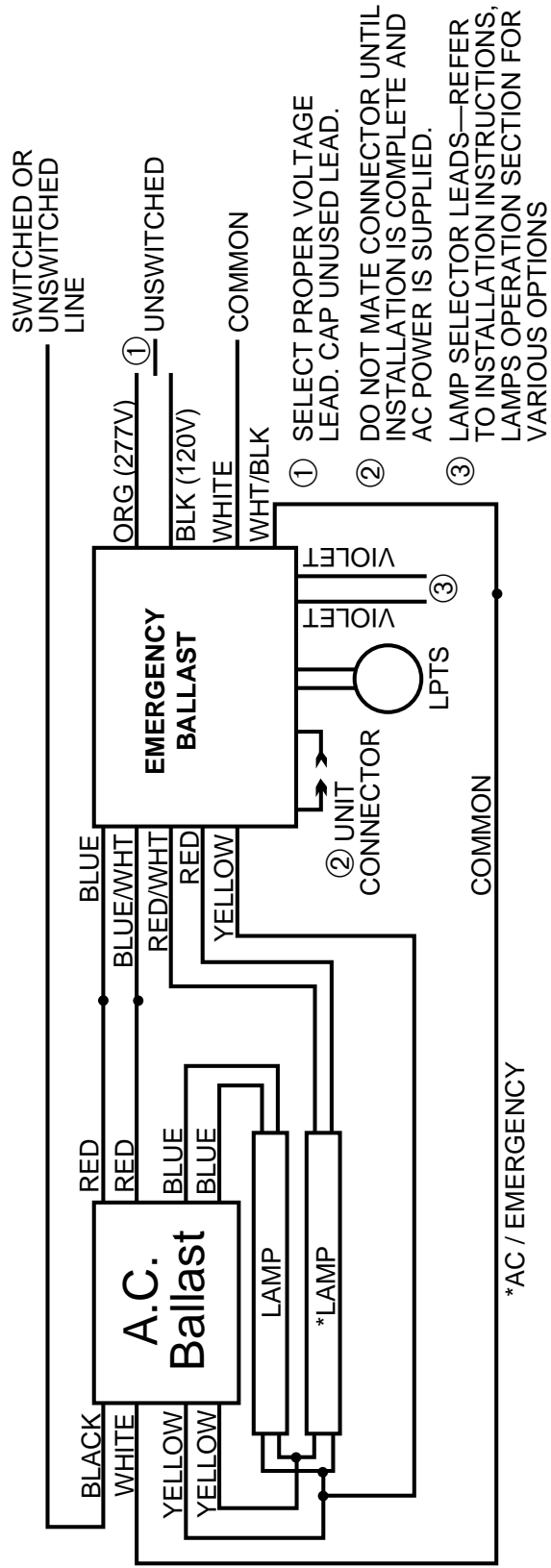

THREE LAMP INSTANT START BALLAST

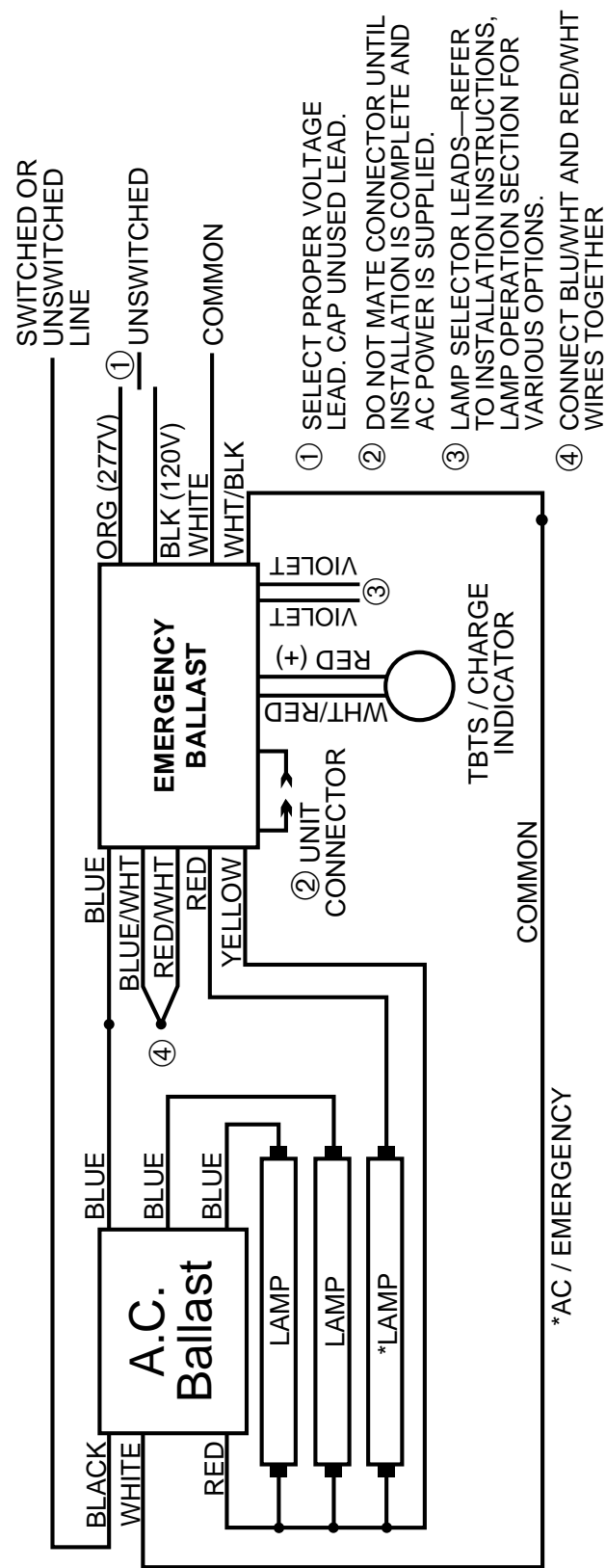

- ① SELECT PROPER VOLTAGE LEAD. CAP UNUSED LEAD.
- ② DO NOT MATE CONNECTOR UNTIL INSTALLATION IS COMPLETE AND AC POWER IS SUPPLIED.
- ③ LAMP SELECTOR LEADS—REFER TO INSTALLATION INSTRUCTIONS, LAMP OPERATION SECTION FOR VARIOUS OPTIONS.
- ④ CONNECT BLU/WHT AND RED/WHT WIRES TOGETHER

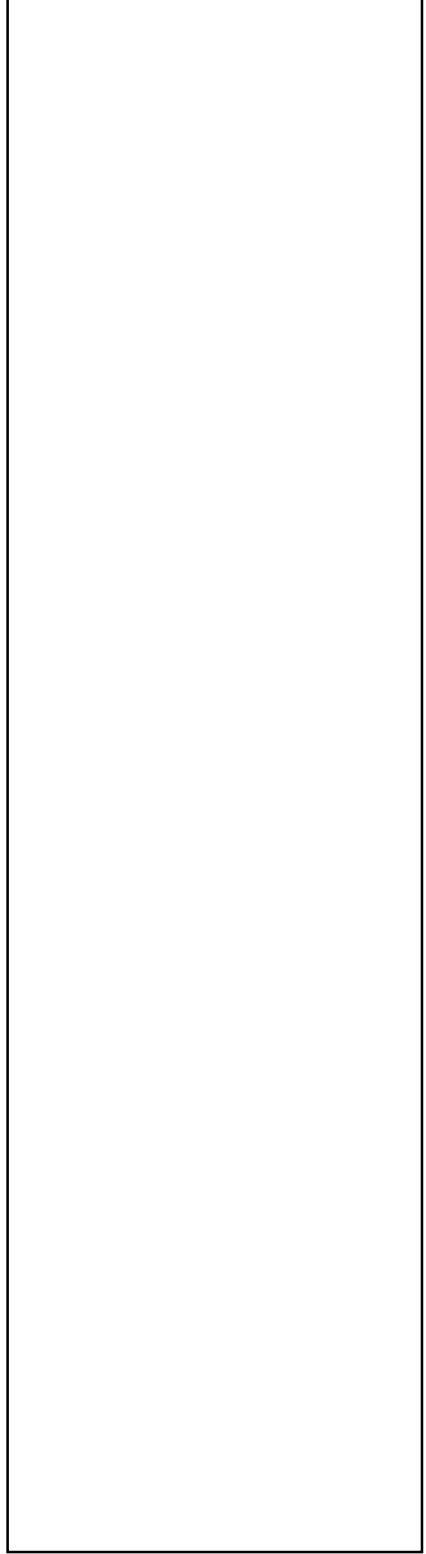

THREE LAMP RAPID START BALLAST

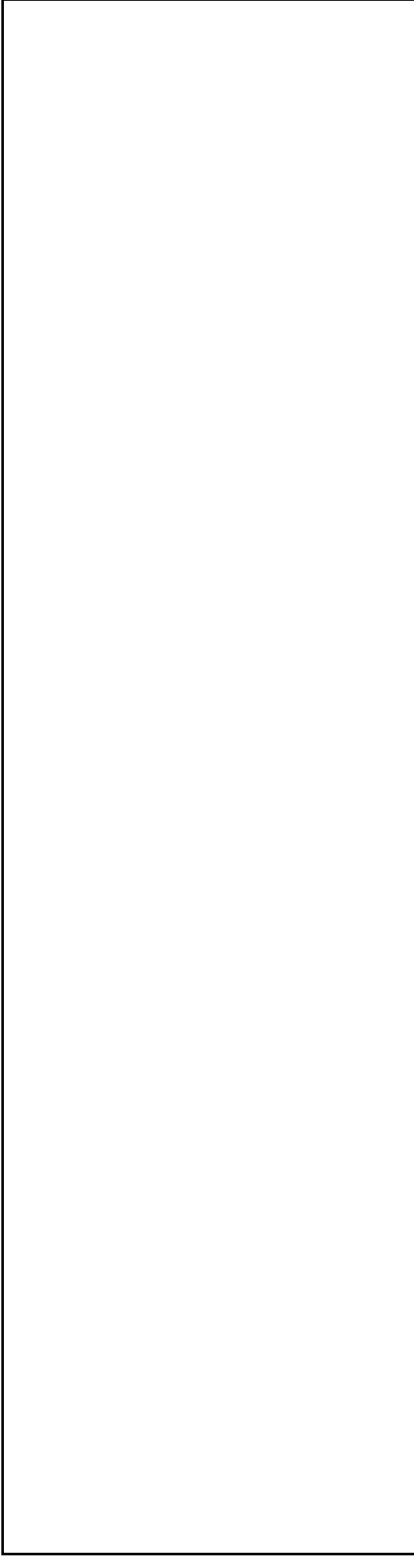
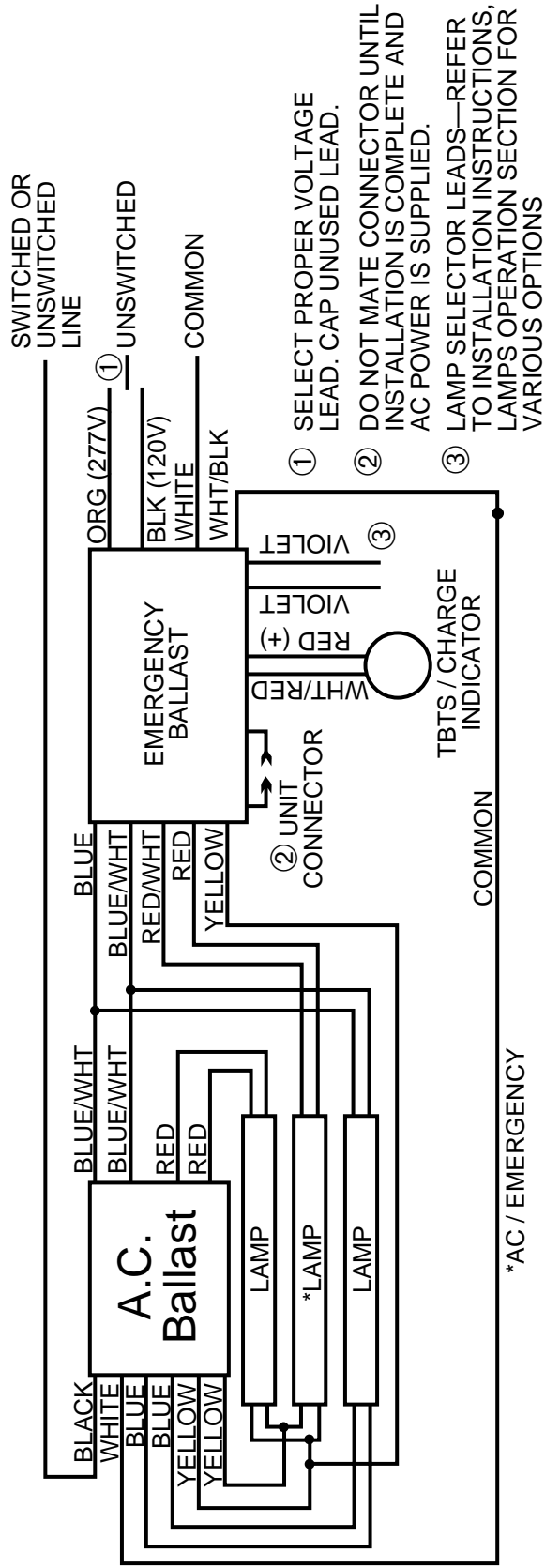

4LISB_D

FOUR LAMP INSTANT START BALLAST

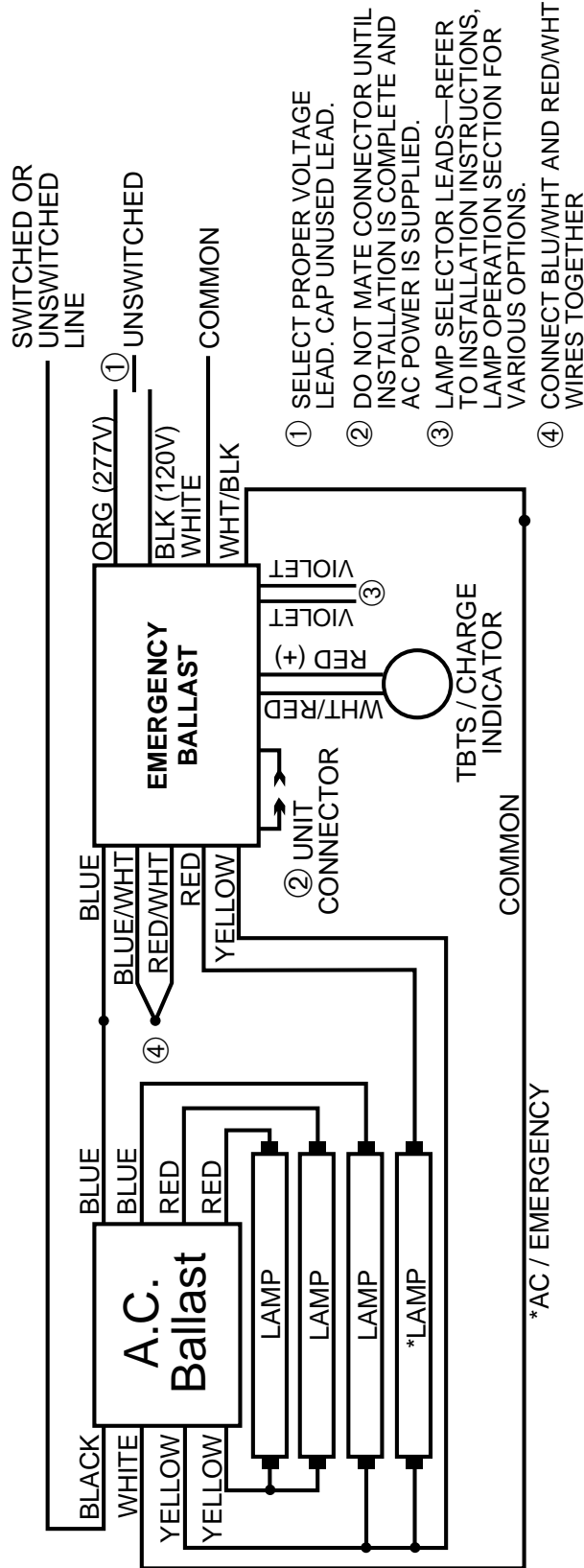

FOR 1 LAMP OPERATION REFER TO: YY20

ADVANCE

RCN/VCN-4P32
REL/VEL-4P32-RH-TP
REL/VEL-4P32-LW-RH-TP

EBT

SSB2-120/277-4/32 IS LH /-(75%)

GE

G4-IN-T8-120/277

GOLDSTAR

GB 4x32/FL/I/120-277
GB 4x32/FL/I/120L-277L

HOWARD

E4/32IS-120/277
EC4/32IS-120/277

KINGTEC

432K120-IS/277-IS
432K120-75%

MAGNETEK

B432120/277HP
B432120/277RH

MOTOROLA

M4-IL-T8-GP-A-120/277
M4-IN-T8-A-120/277
M4-IN-T8-D-120/277
M4-IN-T8-GP-A-120/277

ALL COMPATIBLE BALLASTS MAY NOT BE LISTED.
*DIMMING CONTROL WIRES ARE NOT AFFECTED BY EM PACK

2LISFB2_80D_2LEO

TWO LAMP INSTANT START BALLAST TWO LAMP EMERGENCY OPERATION

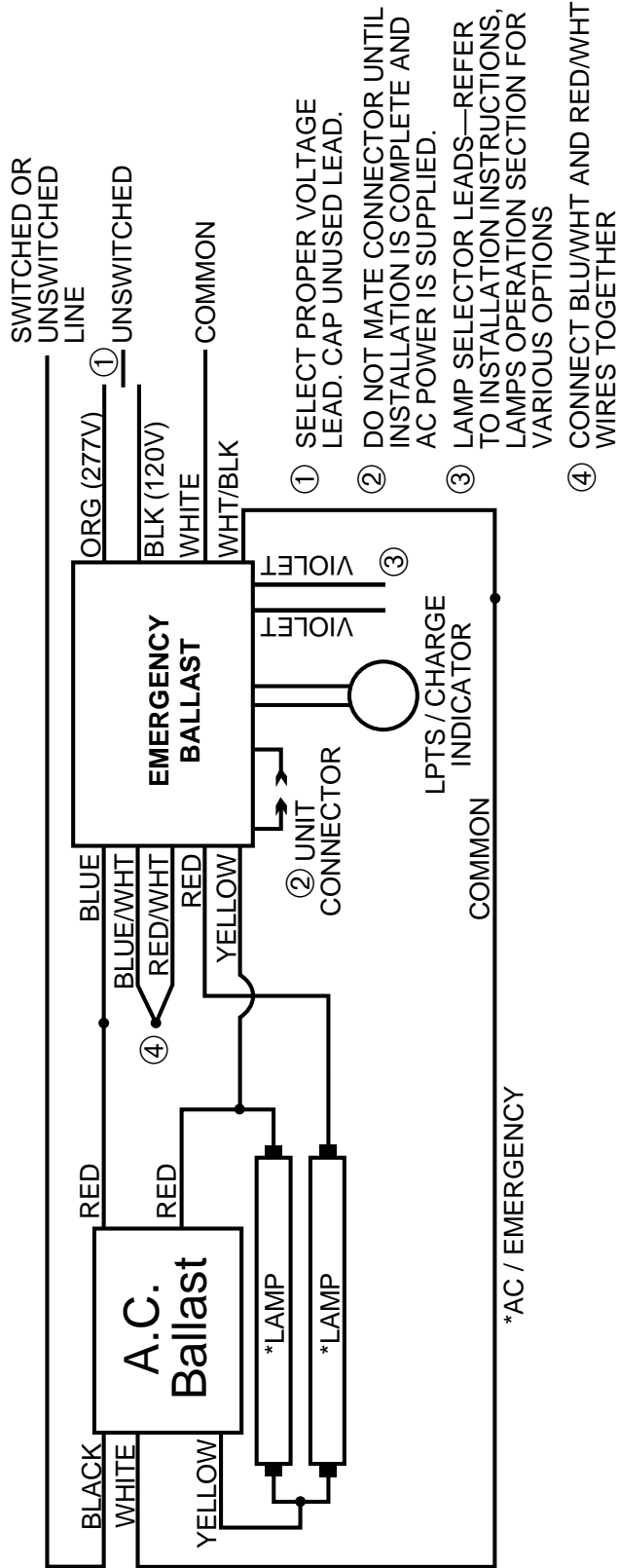

FOR 1 LAMP OPERATION REFER TO: YY15

FULLHAM

WORKHORSE 3

2LISFB2_80D

TWO LAMP INSTANT START BALLAST

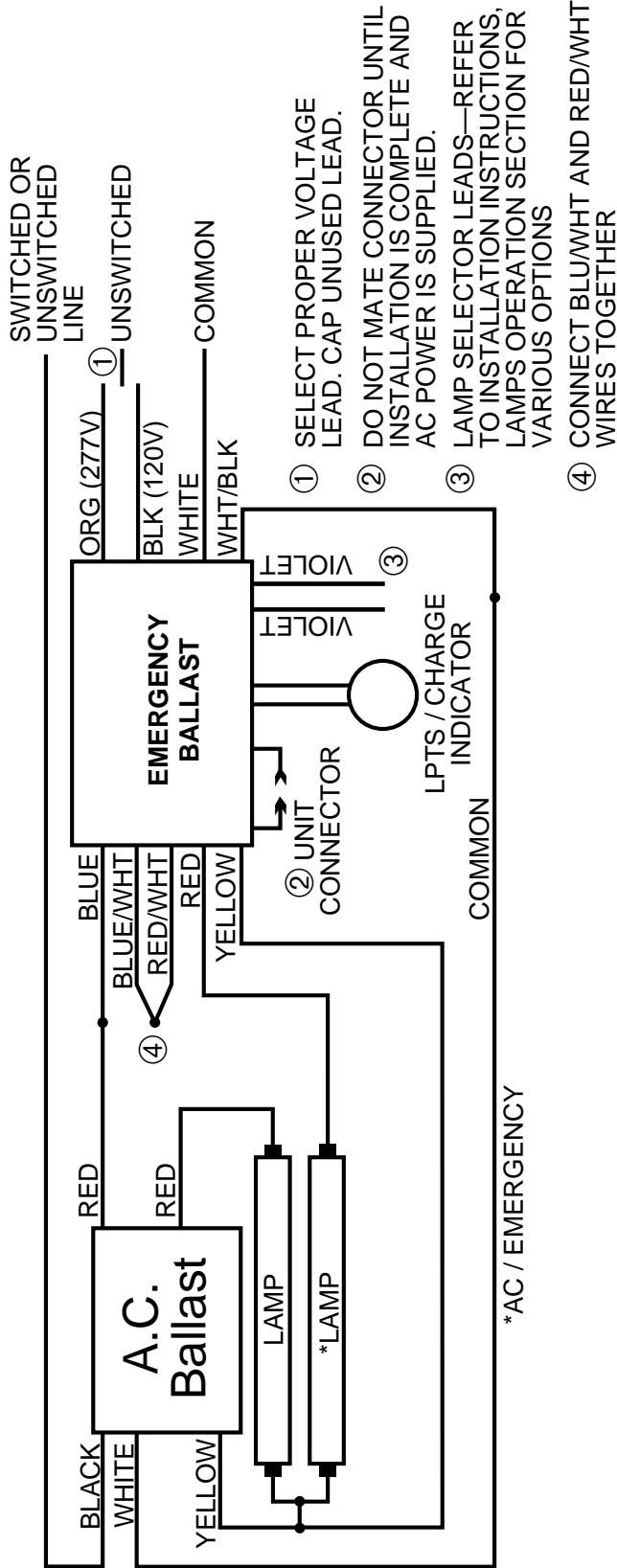

FOR 2 LAMP OPERATION REFER TO: YY14

FULLHAM

WORKHORSE 3

1BXLRSB_D

ONE BIAx LAMP RAPID START BALLAST

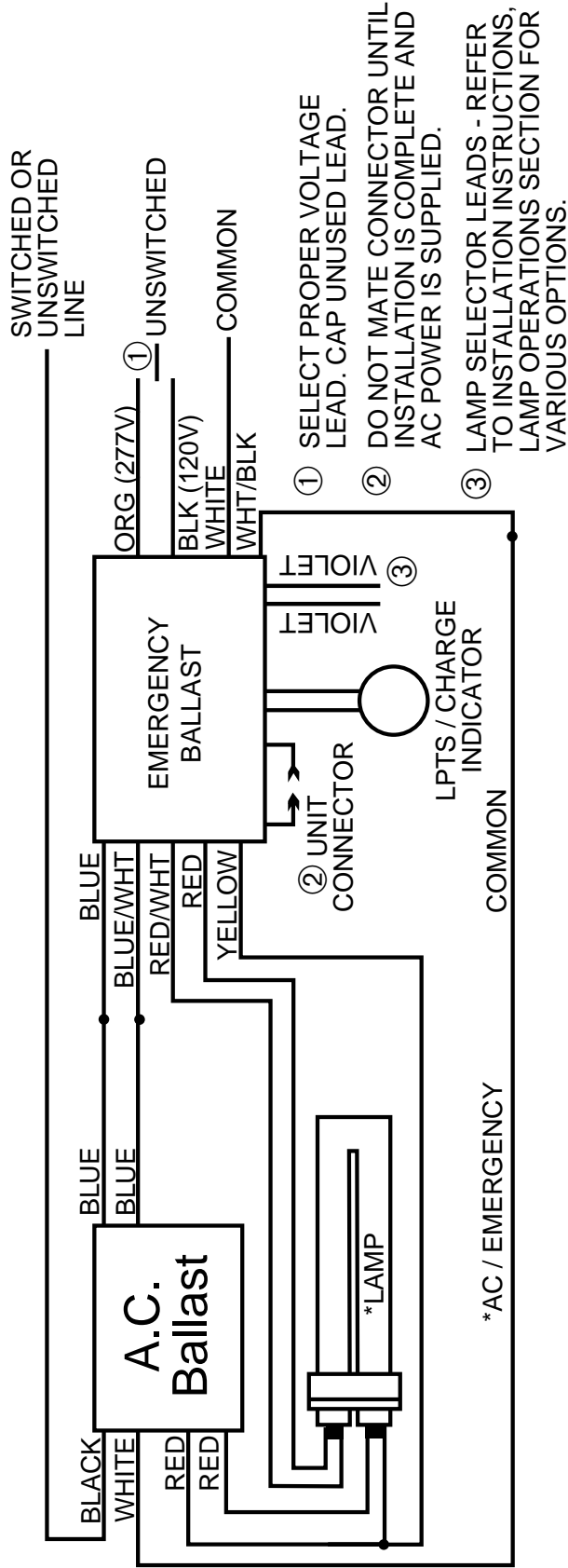

ADVANCE

ICF1Q70M3B5

ALL COMPATIBLE BALLASTS MAY NOT BE LISTED.
*DIMMING CONTROL WIRES ARE NOT AFFECTED BY EM PACK

FOUR LAMP RAPID START BALLAST

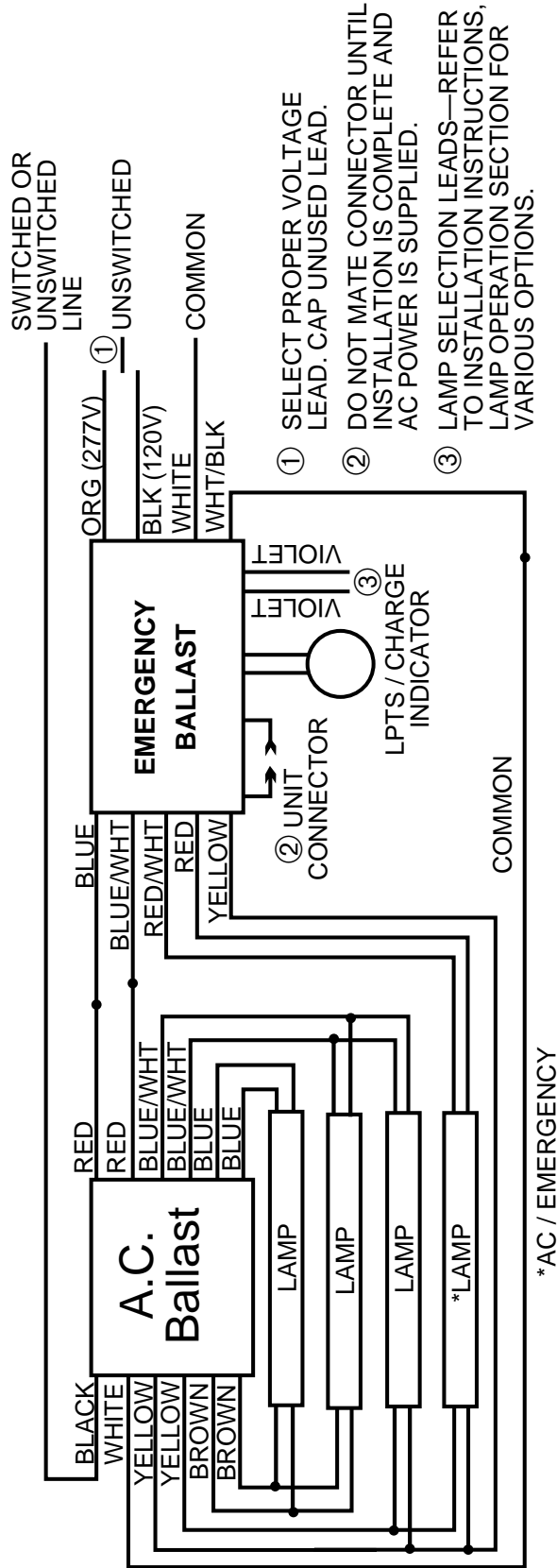

ADVANCE
RC-4S60-TP
RC-4S85-TP
VCN-4S32-SC
GE
G4-RL-T8-1LL-120/277
G4-RN-T8-10C-120/277
G4-RN-T8-1LL-120/277
MOTOROLA
M4-RL-T8-1LL-A-120/277
M4-RL-T8-1LL-B-120/277
M4-RN-T8-1LL-A-120/277
M4-RN-T8-1LL-B-120/277

ALL COMPATIBLE BALLASTS MAY NOT BE LISTED.
 *DIMMING CONTROL WIRES ARE NOT AFFECTED BY EM PACK

3LR5B_2LEO_80_D

THREE LAMP RAPID START BALLAST WITH TWO LAMP EMERGENCY OPERATION

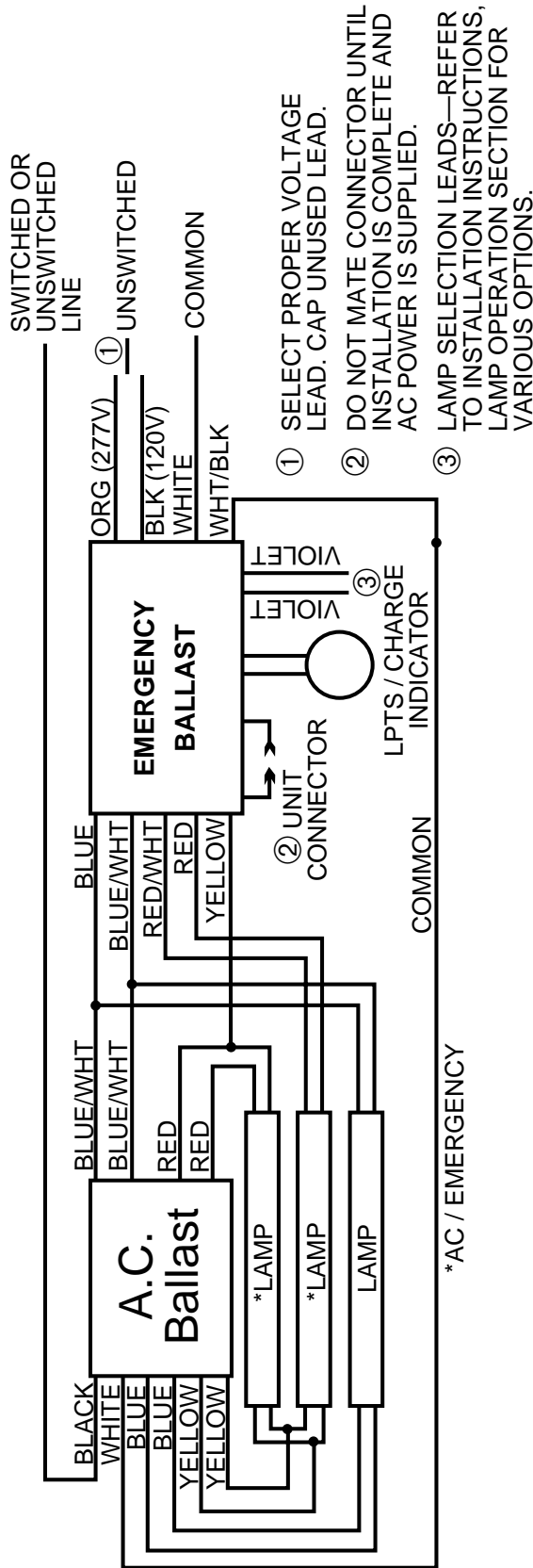

ADVANCE

R/V-3S34-TP
RCN/VCN-3S32
RCN/VCN-3S40
REL/VEL-3S40-RH-TP
RIC/VIC-3S32-TP
RIC/VIC-3S40-TP
RK/VK-3S34-TP
RL-3SP20-TP
RZT/VZT-3S32*
REZ/VEZ-3S32*

EBT

SSB1-120/277-3/32 LH
SSB1-120/277-3/40 LH

GE

G3-RL-T8-1LL-120/277
G3-RN-T8-10C-120/277
G3-RN-T8-1LL-120/277
G3-RN-T12-1LL-120/277

LUTRON

ECO-T832-120/277-3*
FDB-4827-120/277-3*

MOTOROLA

M3-RL-T8-1LL-A-120/277
M3-RN-T12-1LL-B-120/277
M3-RN-T8-1LL-A-120/277

ALL COMPATIBLE BALLASTS MAY NOT BE LISTED.
*DIMMING CONTROL WIRES ARE NOT AFFECTED BY EM PACK

FOUR LAMP INSTANT START BALLAST WITH TWO LAMP EMERGENCY OPERATION

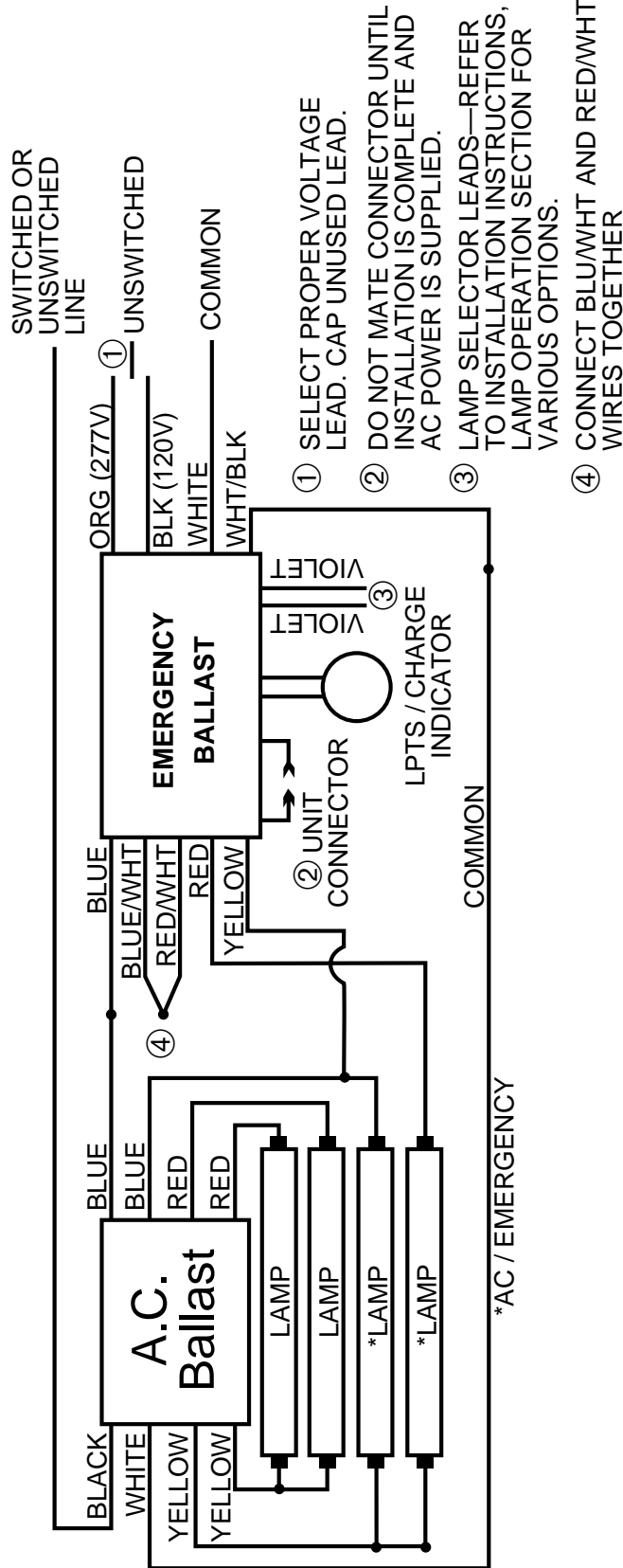

FOR 1 LAMP OPERATION REFER TO: YY13

ADVANCE

RCN/VCN-4P32
REL/VEL-4P32-RH-TP
REL/VEL-4P32-LW-RH-TP

EBT

SSB2-120/277-4/32 IS LH /-(75%)

GE

G4-IN-T8-120/277

GOLDSTAR

GB 4x32/FL/I/120-277
GB 4x32/FL/I/120L-277L

HOWARD

E4/32IS-120/277
EC4/32IS-120/277

KINGTEC

432K120-IS/277-IS
432K120-75%

MAGNETEK

B4321120/277HP
B4321120/277RH

MOTOROLA

M4-IL-T8-GP-A-120/277
M4-IN-T8-A-120/277
M4-IN-T8-D-120/277
M4-IN-T8-GP-A-120/277

ALL COMPATIBLE BALLASTS MAY NOT BE LISTED.
*DIMMING CONTROL WIRES ARE NOT AFFECTED BY EM PACK

THREE LAMP RAPID START BALLAST WITH DIMMING LEAD TWO LAMP EMERGENCY OPERATION

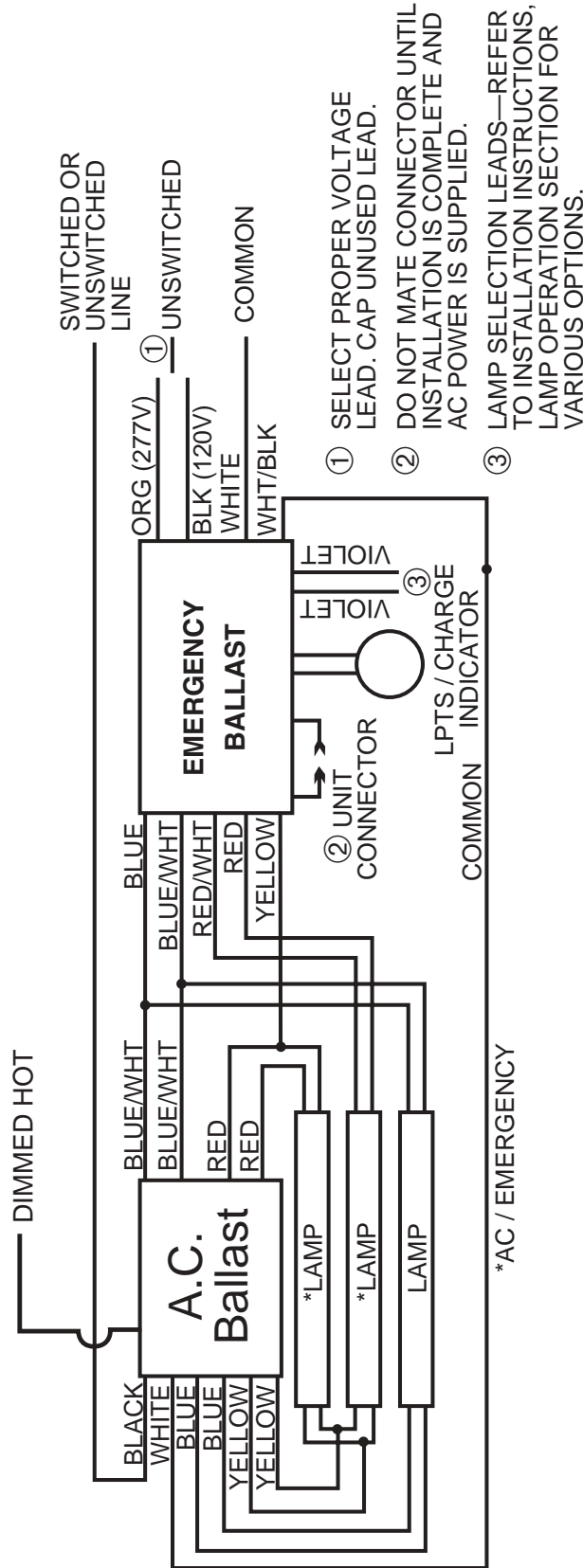

WITHOUT DIMMING LEAD REFER TO: YY19

ADVANCE
R/V-3S34-TP
RCN/VCN-3S32
RCN/VCN-3S40
REL/VEL-3S40-RH-TP
RIC/MIC-3S32-TP
RIC/MIC-3S40-TP
RK/VK-3S34-TP
RL-3SP20-TP
RZT/VZT-3S32*
REZ/VEZ-3S32*
EBT
SSB1-120/277-3/32 LH
SSB1-120/277-3/40 LH
GE
G3-RL-T8-1LL-120/277
G3-RN-T8-10C-120/277
G3-RN-T8-1LL-120/277
G3-RN-T12-1LL-120/277
LUTRON
ECO-T832-120/277-3*
FDB-4827-120/277-3*
MOTOROLA
M3-RL-T8-1LL-A-120/277
M3-RN-T12-1LL-B-120/277
M3-RN-T8-1LL-A-120/277

ALL COMPATIBLE BALLASTS MAY NOT BE LISTED.
*DIMMING CONTROL WIRES ARE NOT AFFECTED BY EM PACK

1LISB_CL_D

ONE LAMP INSTANT START BALLAST WITH CHARGE INDICATOR AND TEST SWITCH

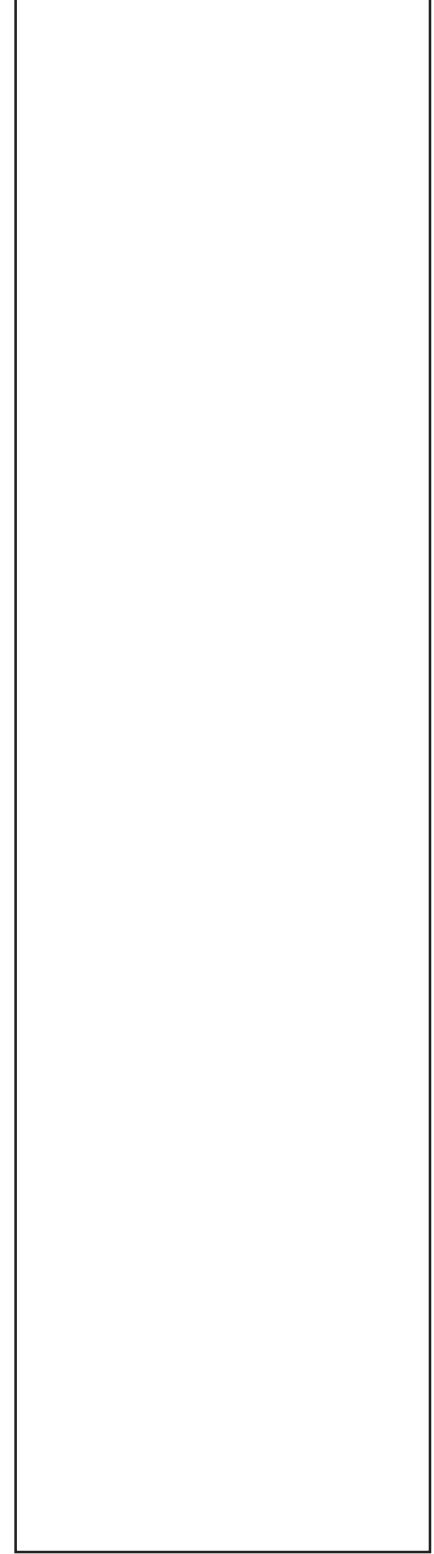
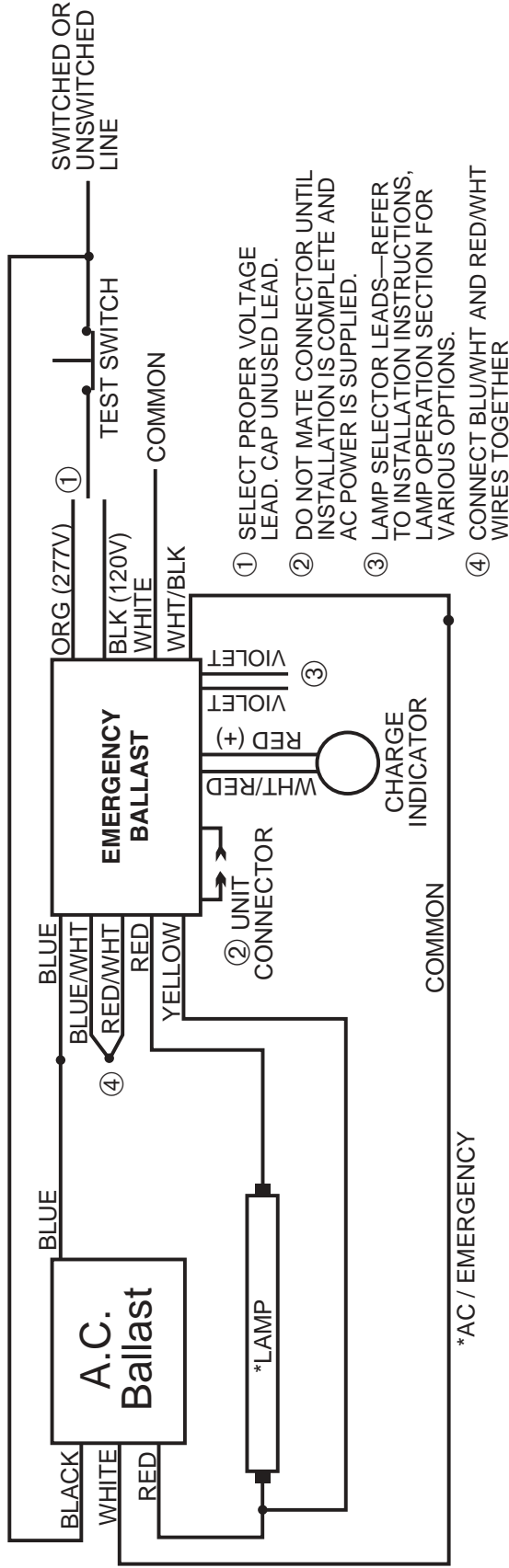

TWO LAMP EMERGENCY ONLY

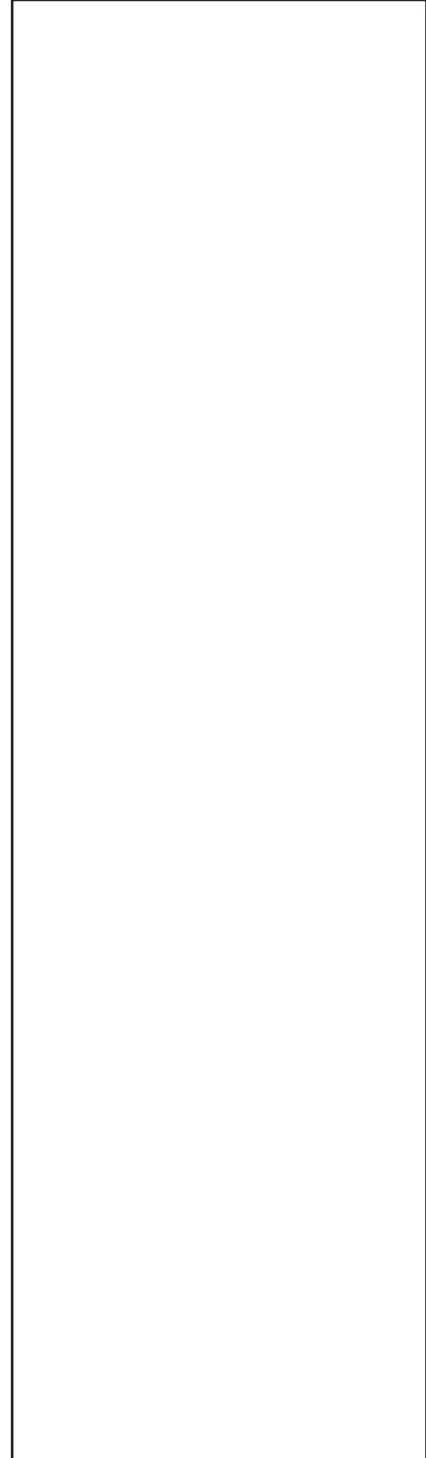
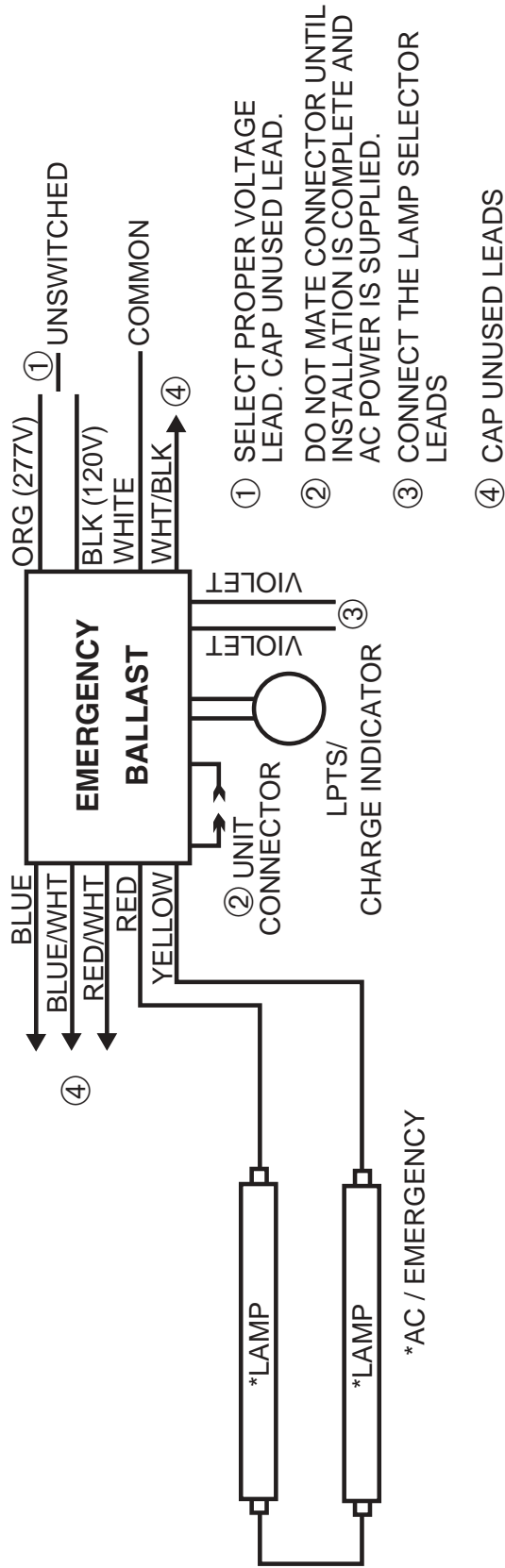

ONE LAMP INSTANT START BALLAST

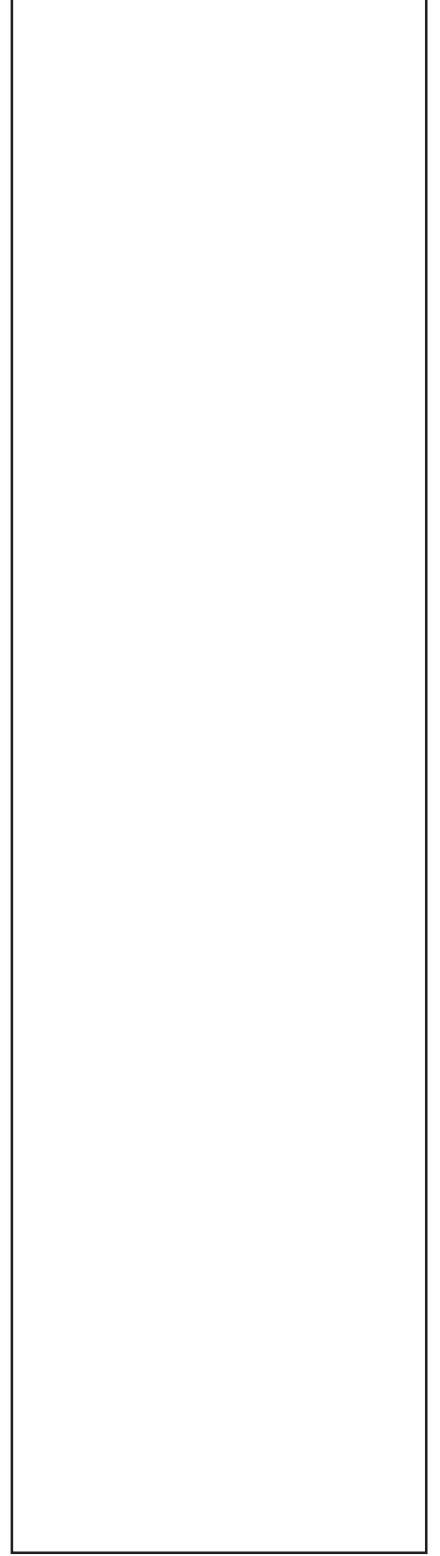
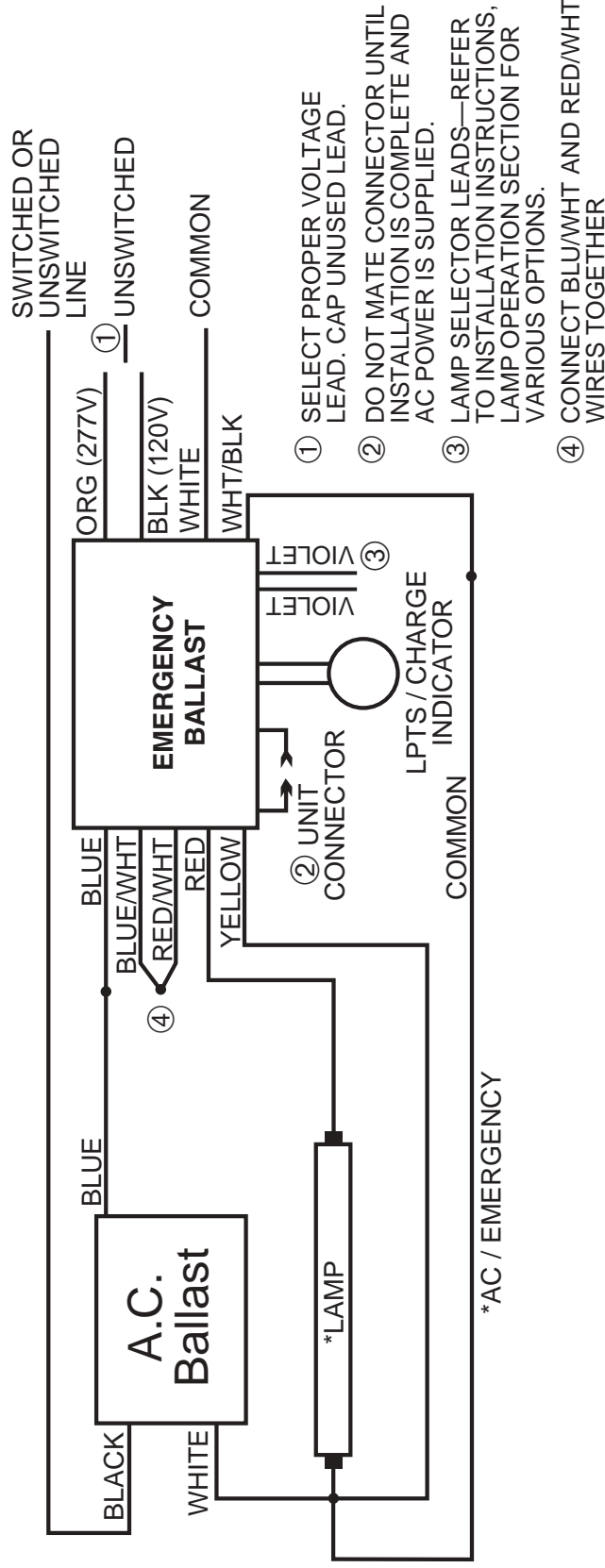

1LLAG_D

ONE LAMP LAG BALLAST

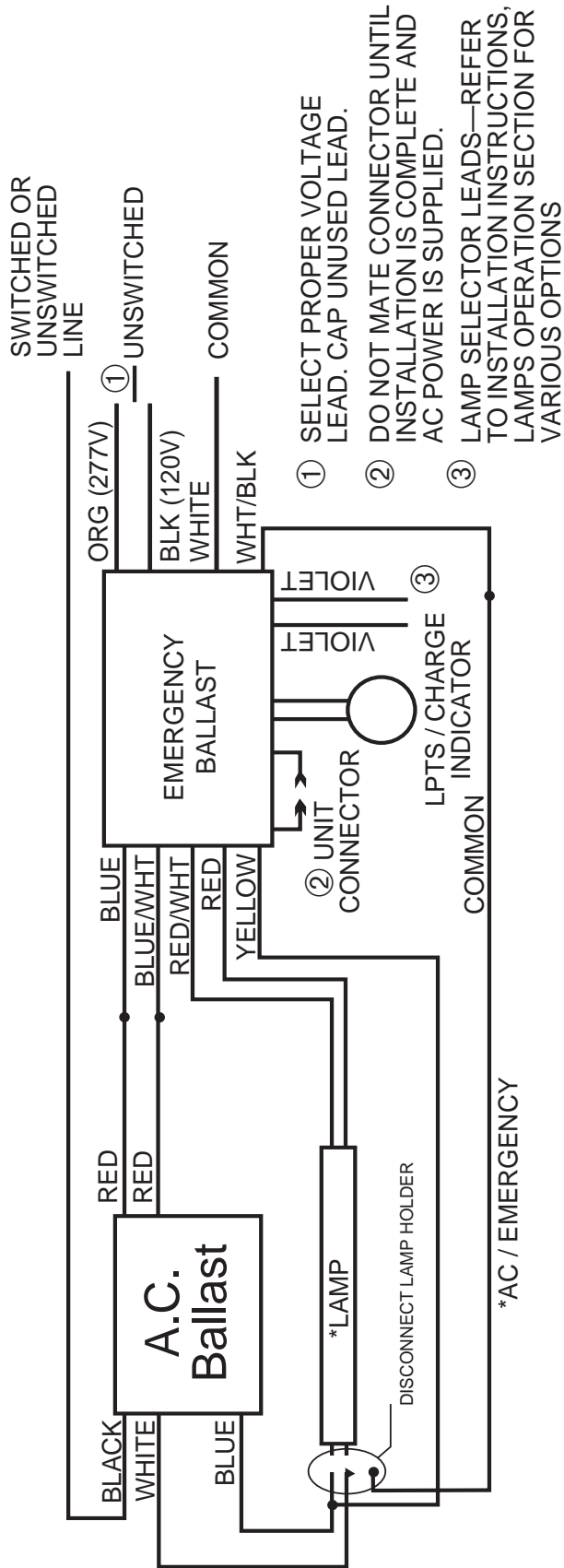

ADVANCE

RL-140-TP

MAGNETEK

543-B

ALL COMPATIBLE BALLASTS MAY NOT BE LISTED.
*DIMMING CONTROL WIRES ARE NOT AFFECTED BY EM PACK

1LISB_347_D

ONE LAMP INSTANT START BALLAST WITH 347V CONVERTER

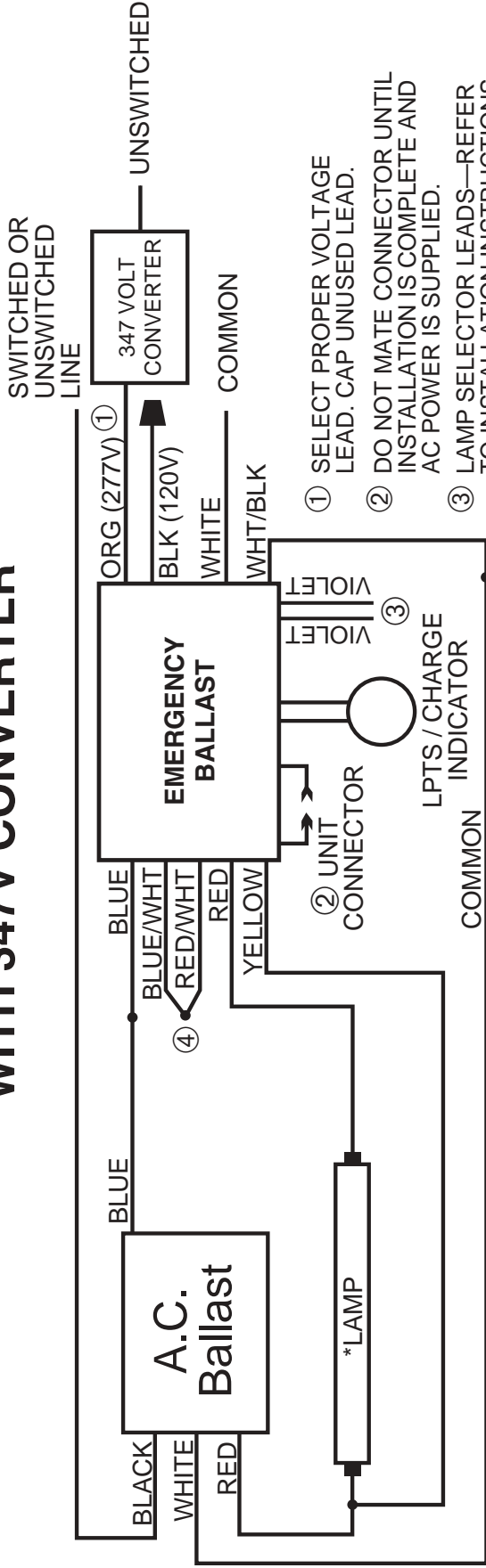

- ① SELECT PROPER VOLTAGE LEAD. CAP UNUSED LEAD.
- ② DO NOT MATE CONNECTOR UNTIL INSTALLATION IS COMPLETE AND AC POWER IS SUPPLIED.
- ③ LAMP SELECTOR LEADS—REFER TO INSTALLATION INSTRUCTIONS, LAMP OPERATION SECTION FOR VARIOUS OPTIONS.
- ④ CONNECT BLU/WHT AND RED/WHT WIRES TOGETHER

*AC / EMERGENCY

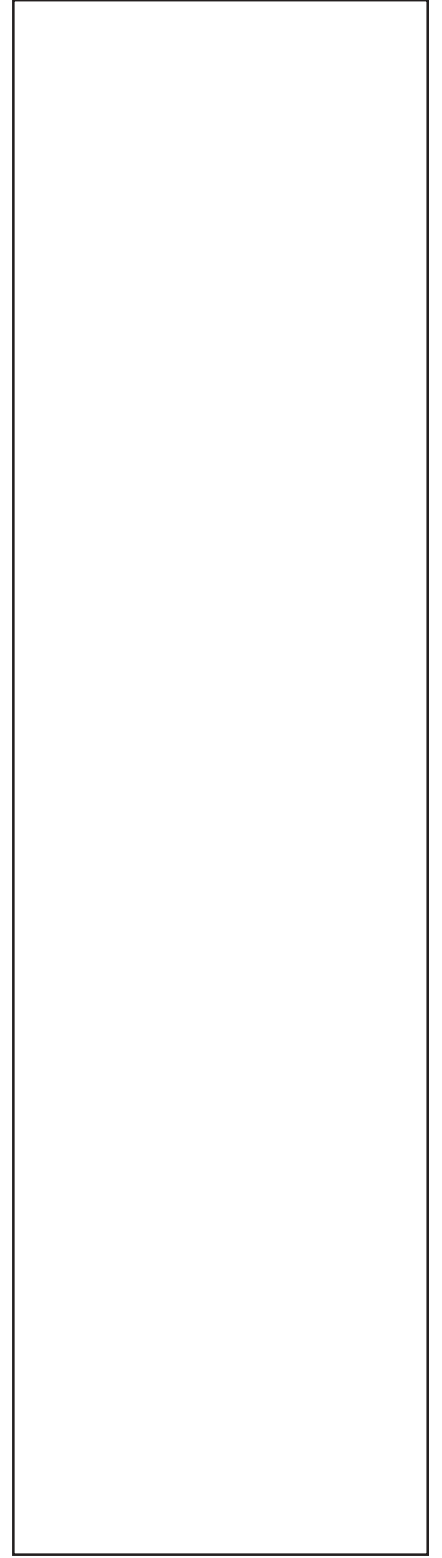

2LRSB_D_3

TWO LAMP RAPID START BALLAST

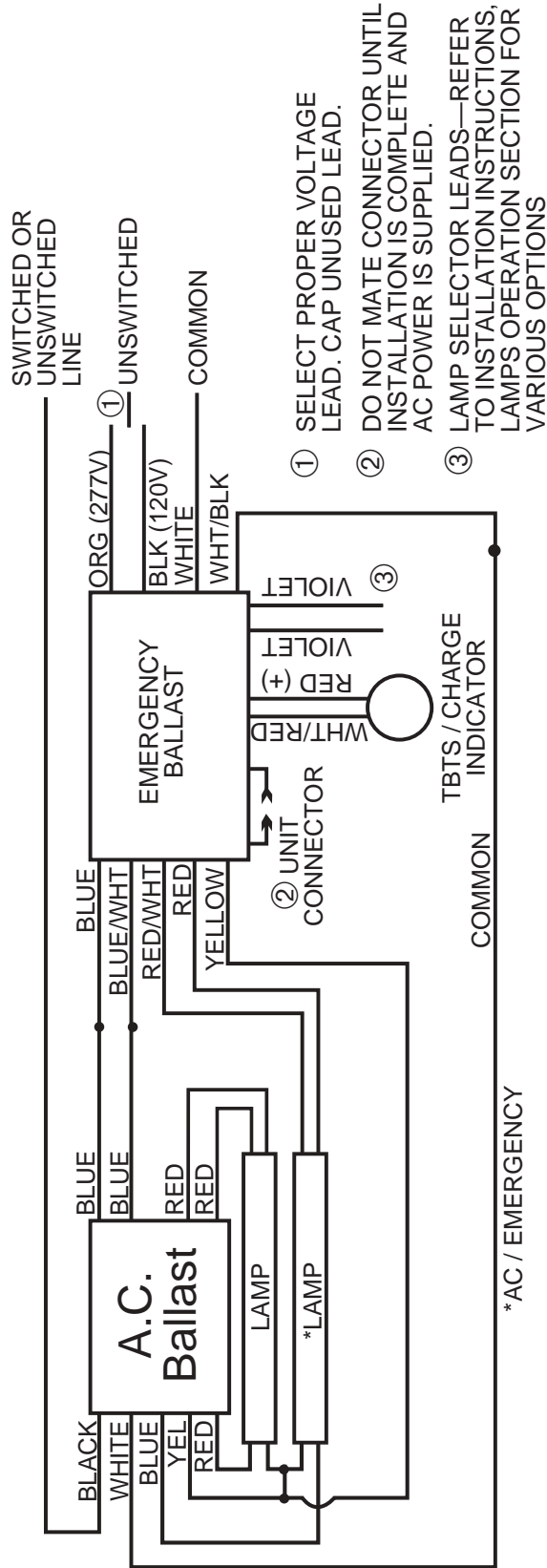

SUNPARK

SL-15P

2LISBX_D

TWO BIAX LAMP INSTANT START BALLAST

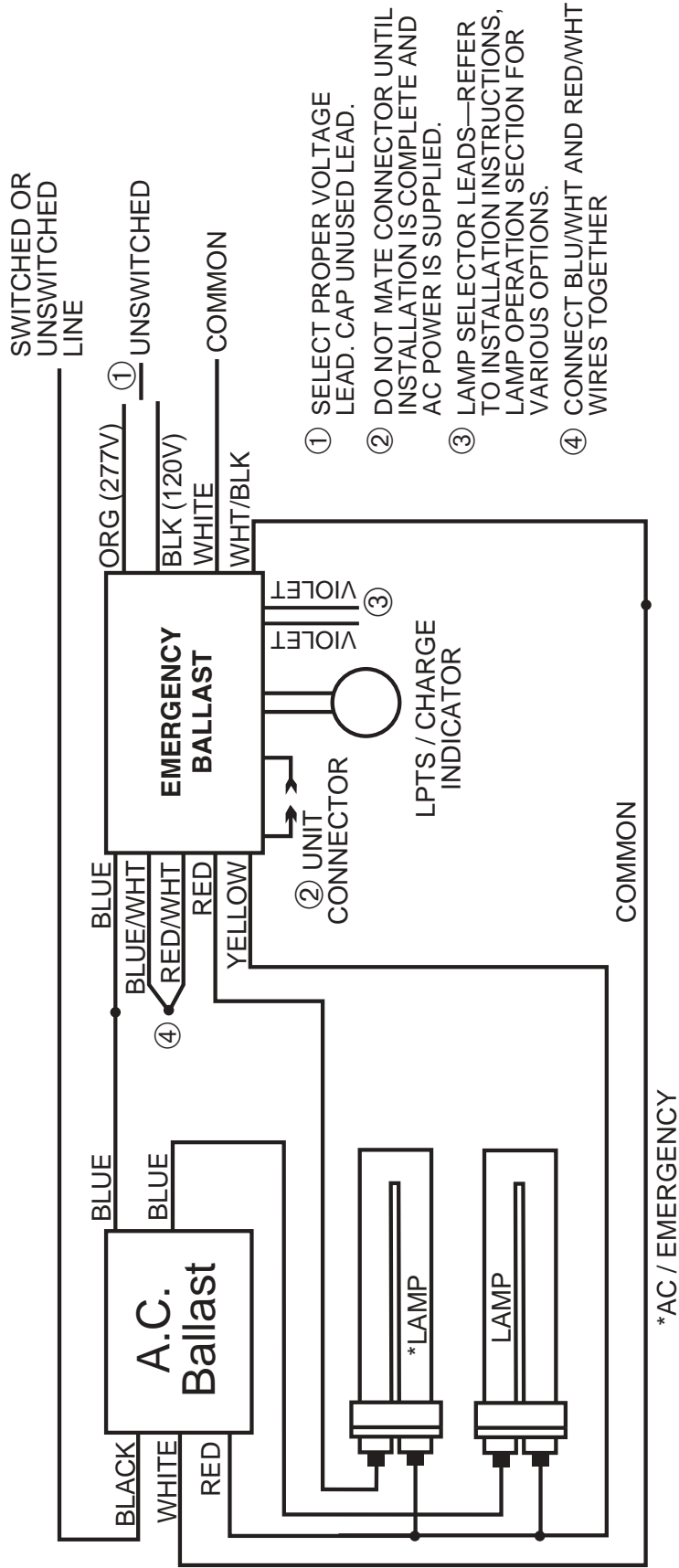

ADVANCE	
RCN-2TTP40	
MAGNETEK	
B2321120/277HP	
B2321120/277RH	
MOTOROLA	
M2-IL-T8-GP-120/277	
M2-IN-T8-D-120/277	
M2-IN-T8-1LL-D-120/277	
M2-IN-T8-GP-120/277	
ALL COMPATIBLE BALLASTS MAY NOT BE LISTED. *DIMMING CONTROL WIRES ARE NOT AFFECTED BY EM PACK	

TWO LAMP BALLAST

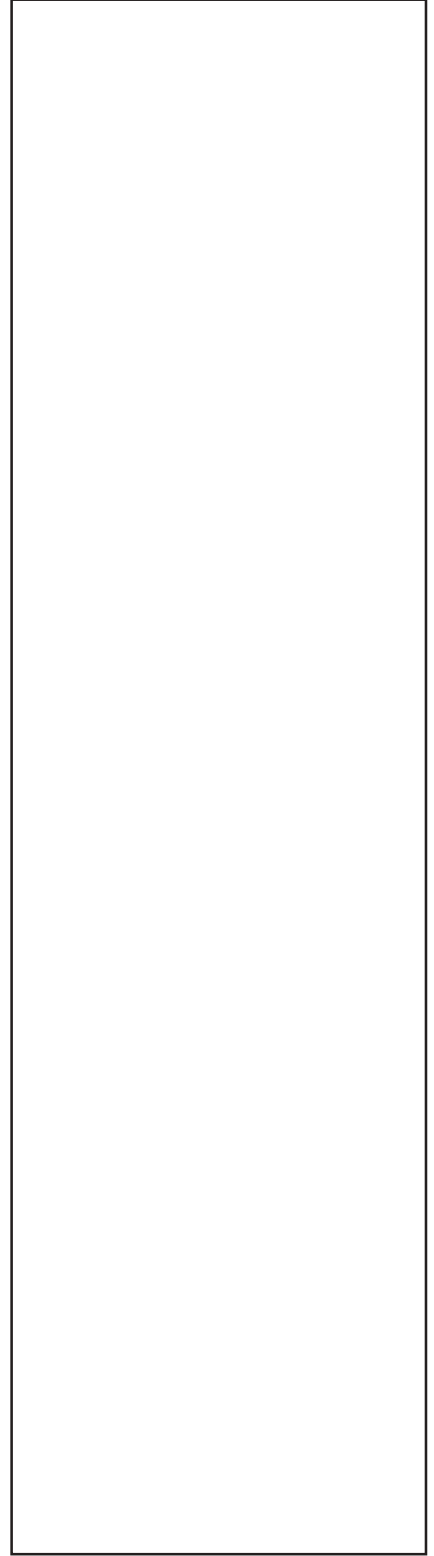
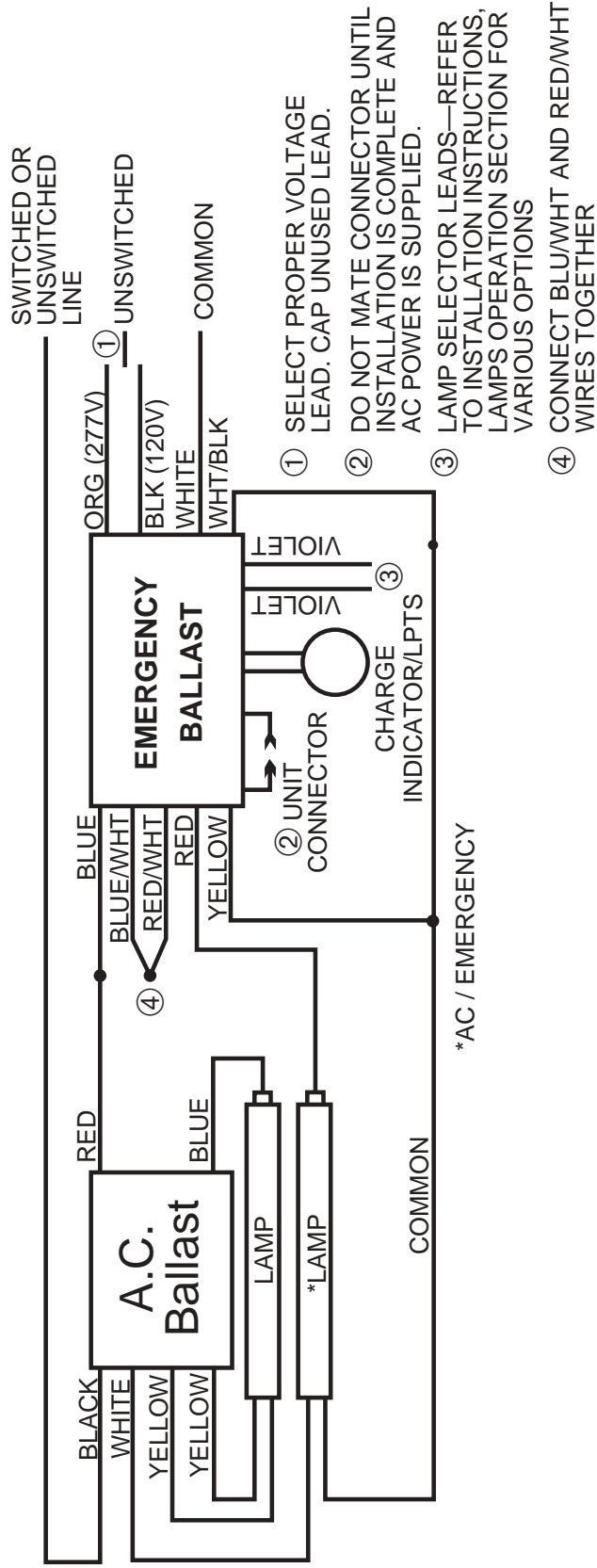

2LR5B_D_4

TWO LAMP RAPID START BALLAST

