

Thomas & Betts

**EMERGENCY BALLAST
WIRING GUIDE**

rev. 103103



HOW TO USE THE EMERGENCY BALLAST WIRING GUIDE

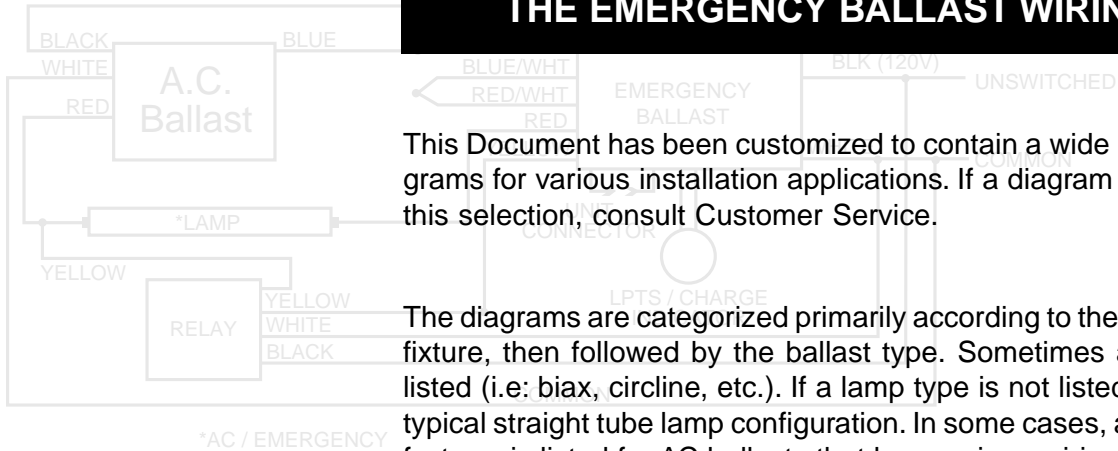

This Document has been customized to contain a wide library of individual diagrams for various installation applications. If a diagram cannot be found within this selection, consult Customer Service.

The diagrams are categorized primarily according to the number of lamps in the fixture, then followed by the ballast type. Sometimes a specific lamp type is listed (i.e: biax, circline, etc.). If a lamp type is not listed, the diagram shows a typical straight tube lamp configuration. In some cases, a specific ballast manufacturer is listed for AC ballasts that have unique wiring arrangements.

Diagrams for specific situations can be located within this PDF file by using the following methods:

1) USING THE NAVIGATION WINDOW

Use the Navigation window and select the Emergency Ballast for which the diagram is needed, then scroll through the list of applications to find the diagram(s) that meet the necessary criteria by clicking on the “plus” sign next to the Unit Model. (Many of the diagrams are bookmarked with identical descriptions. Examine the diagram for details as to whether or not it applies to your situation.)

NOTE: The order in which the pages are bookmarked is not indicative of the actual page order, therefore, continuing to the next page after a “Two Lamp Ballast” diagram may not necessarily take you to another “Two Lamp Ballast” diagram. To aid in locating specific diagrams, each has been bookmarked and categorized in the navigation window.

2) USING THE FIND COMMAND

Some diagrams feature a Model List for reference. If you know the actual model number of the AC ballast that the emergency unit is being wired to, you may use the “FIND” tool in the toolbar (Denoted by the binocular icon) to search the diagrams for that particular model. FIND commands may or may not be successful, since not all ballasts models are listed within this file.

When using the FIND command, it may be helpful to search for only the first few letters or numbers of the model number (i.e. “RCN” or “ECO”) due to the nature of how the reference lists are compiled. Include any hyphens or slashes that may appear in the model number when using the FIND command.

This Guide is by no means an exhaustive record of all AC Ballast/Emergency Unit combinations. If a search using the FIND command or Navigation window is not successful, contact Customer Service for further assistance.

You may request an updated Wiring Diagram Guide at anytime. Please consult Customer Service to find out if a later version with any additions and/or corrections is available.

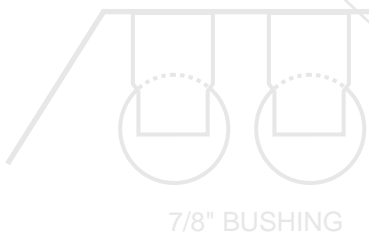
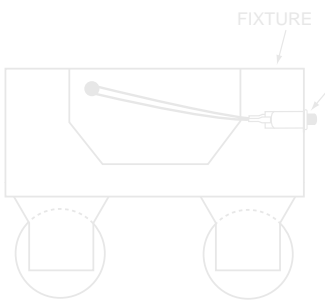
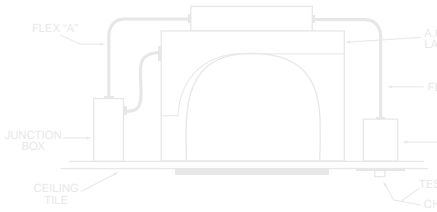

ONE LAMP RAPID START BALLAST

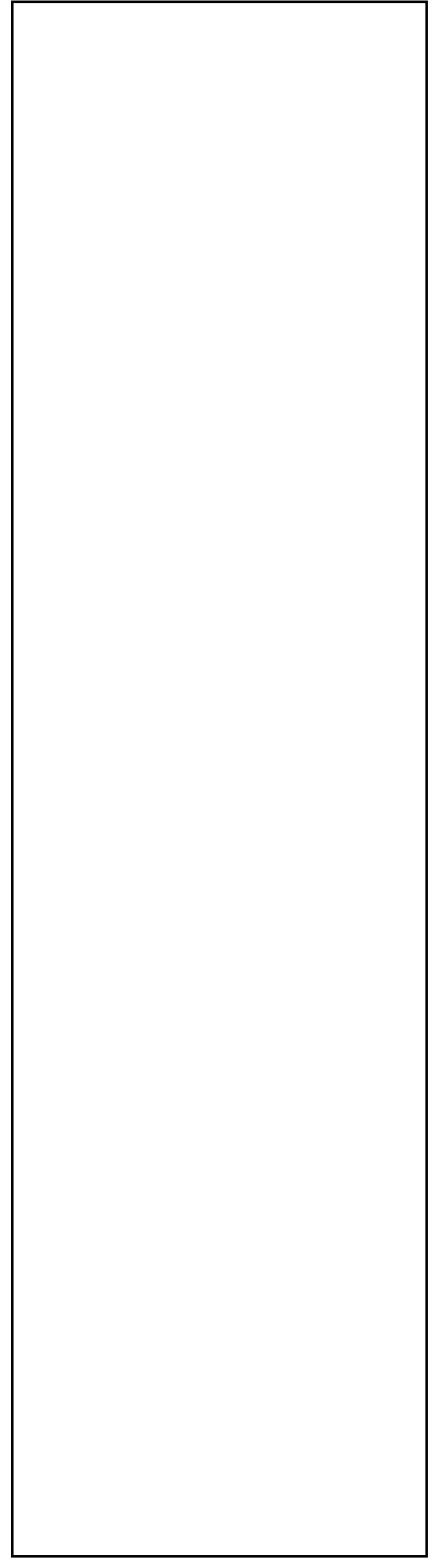
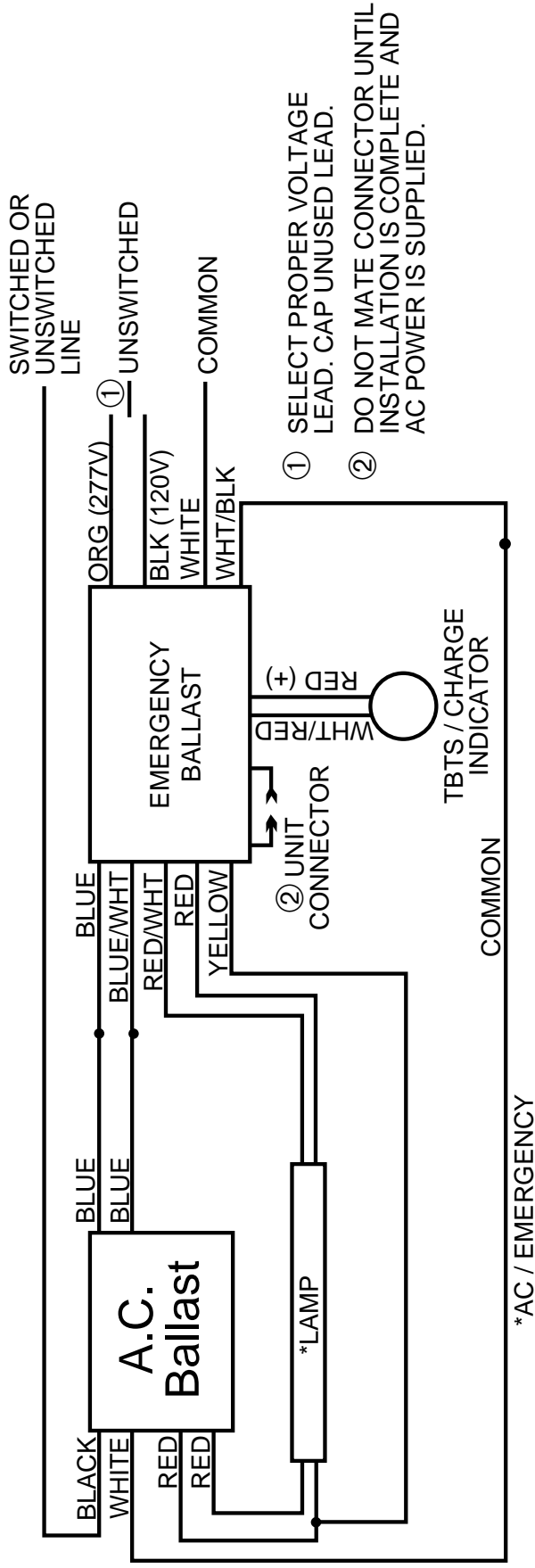

2LR5B

TWO LAMP RAPID START BALLAST

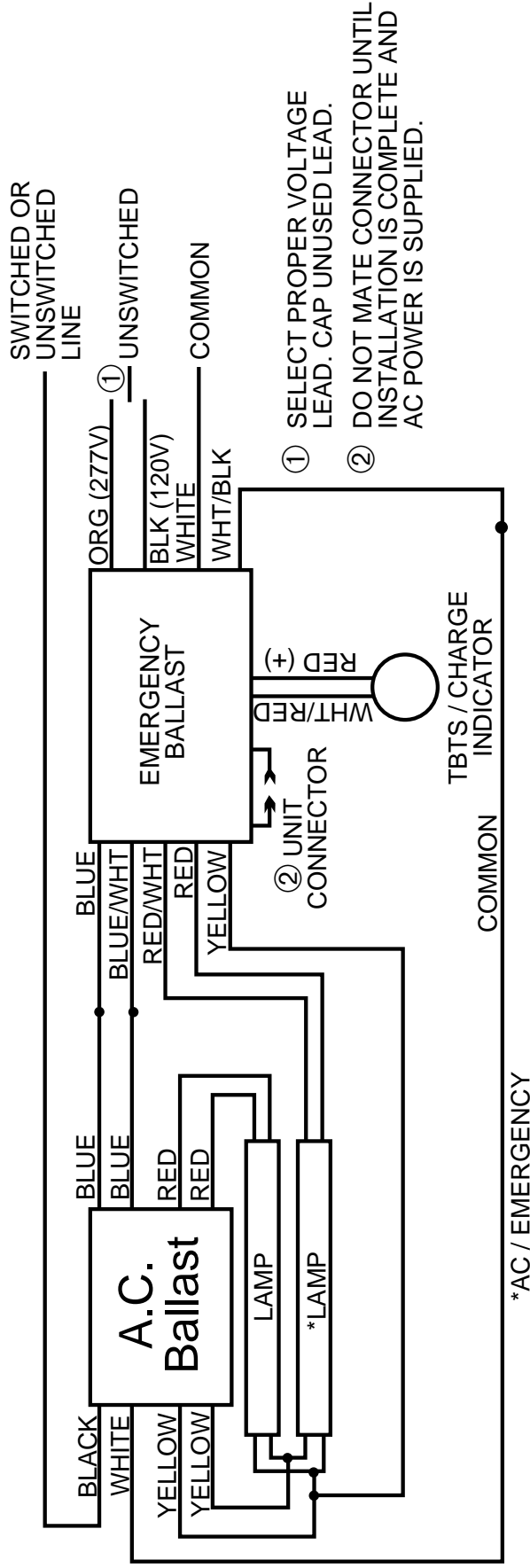

- ① SELECT PROPER VOLTAGE LEAD. CAP UNUSED LEAD.
- ② DO NOT MATE CONNECTOR UNTIL INSTALLATION IS COMPLETE AND AC POWER IS SUPPLIED.

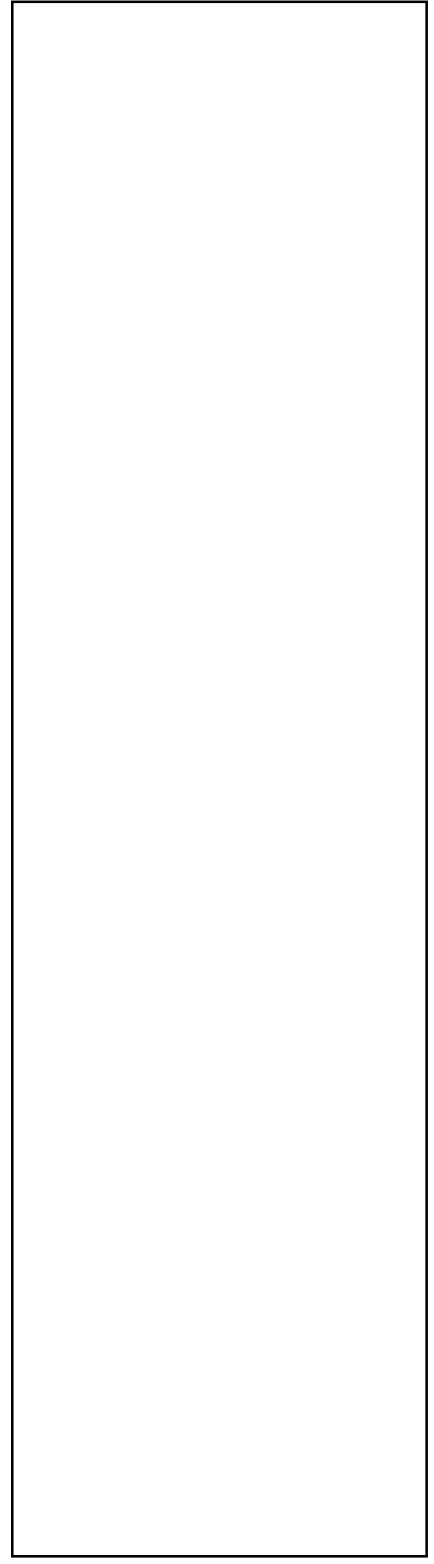

TWO LAMP RAPID START BALLAST

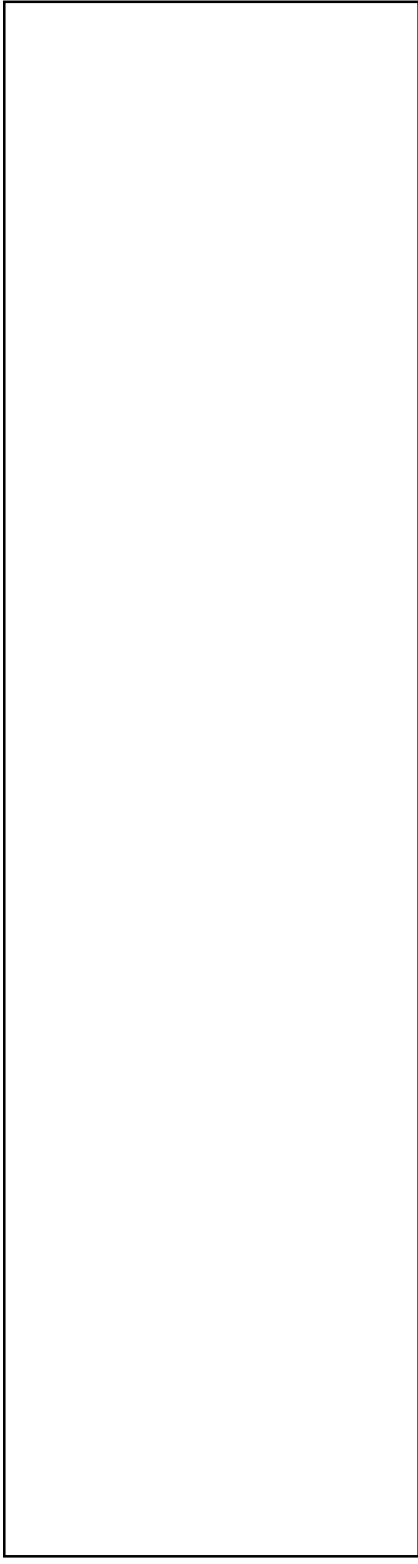
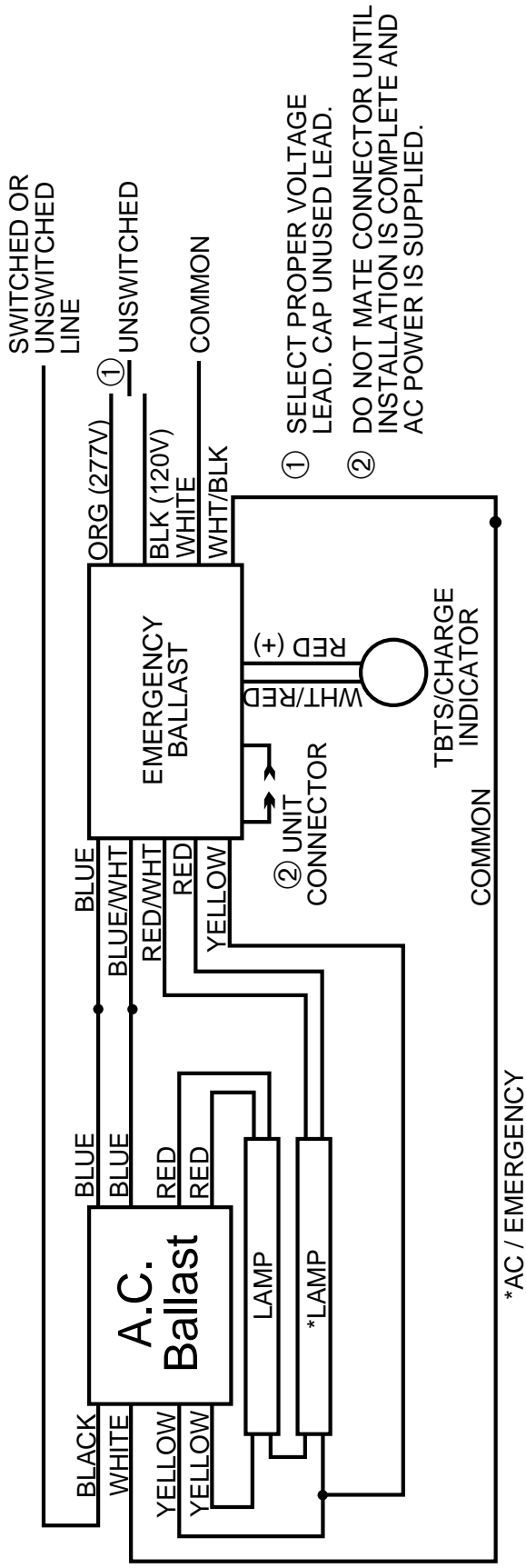

3LR5B_ISL

THREE LAMP RAPID START BALLAST

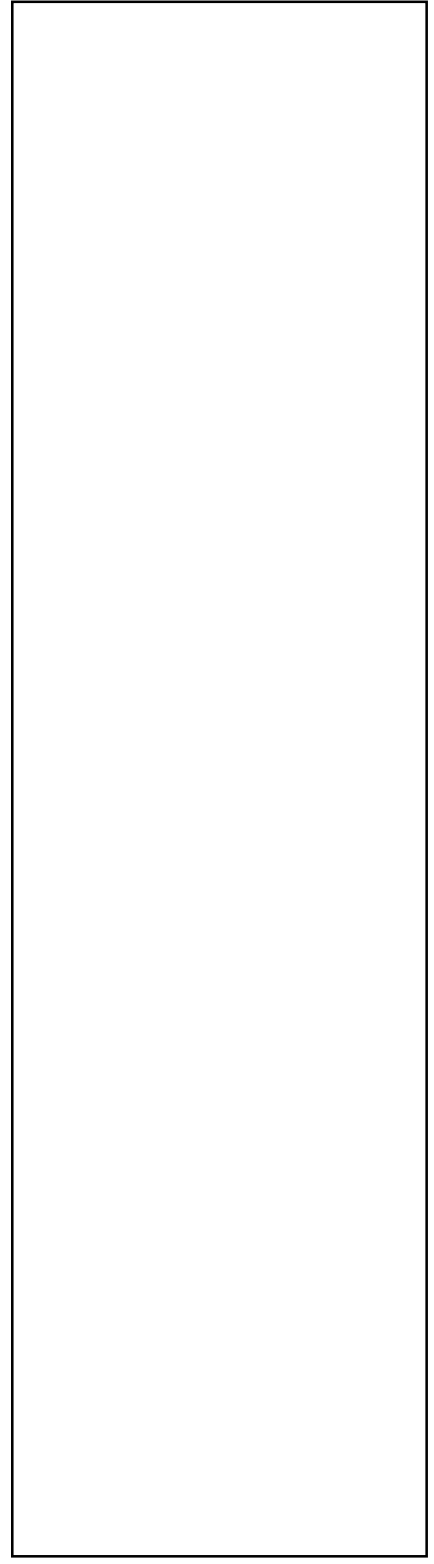
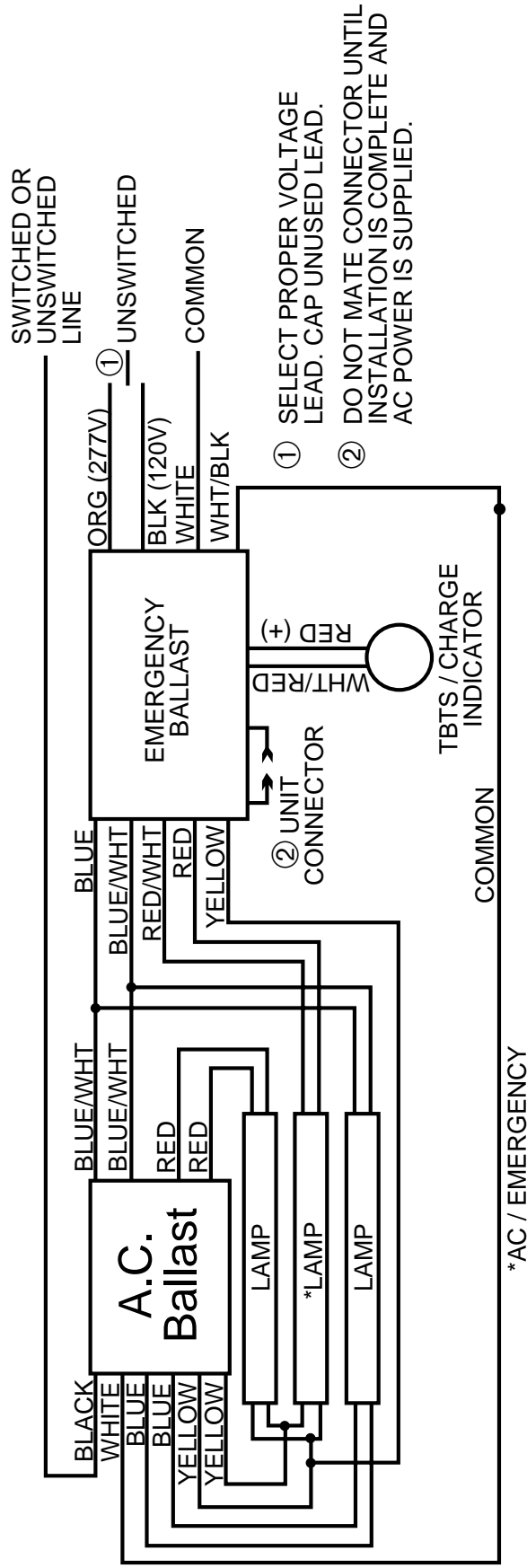

ONE LAMP INSTANT START BALLAST

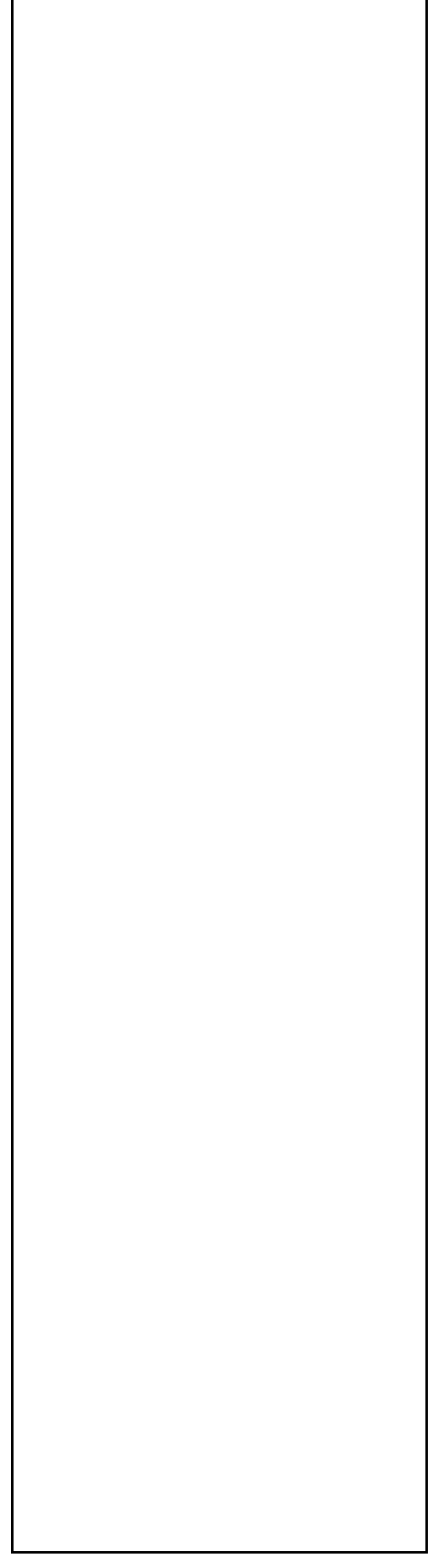
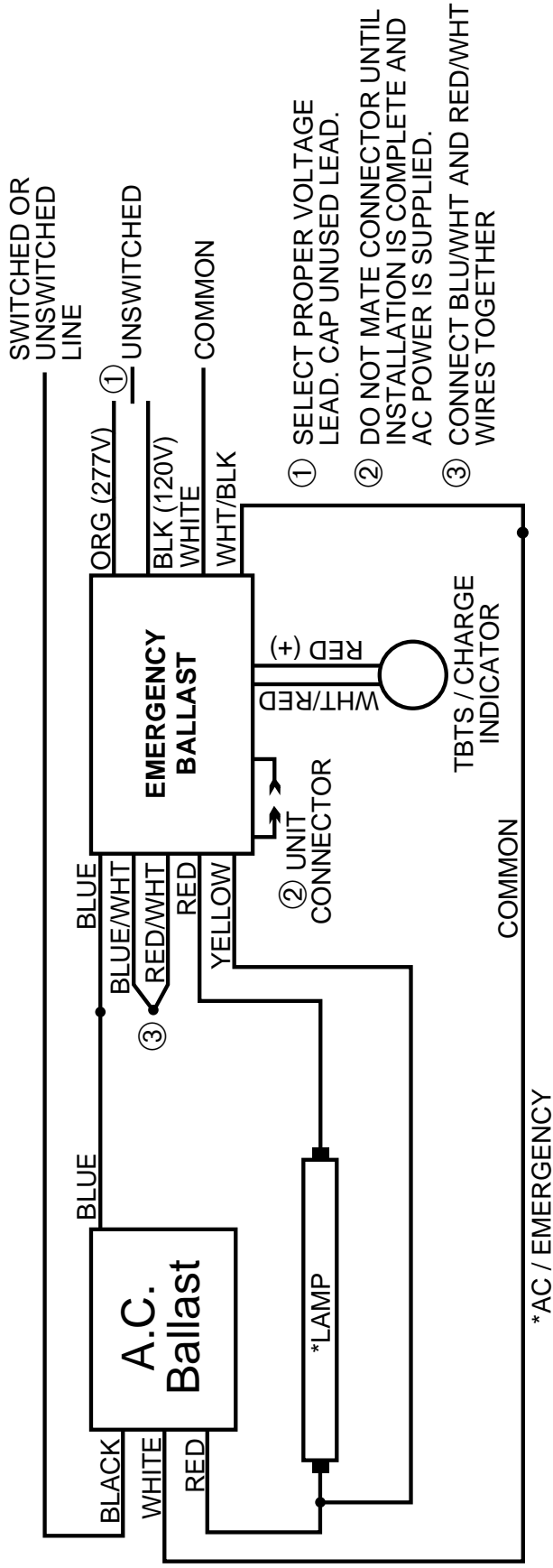

TWO LAMP INSTANT START BALLAST

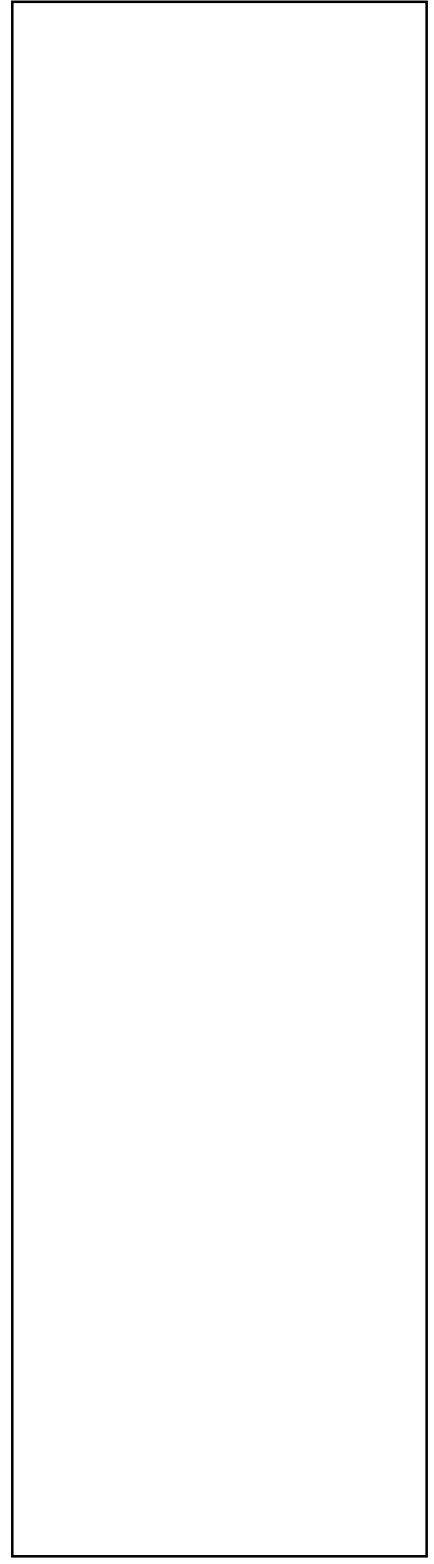
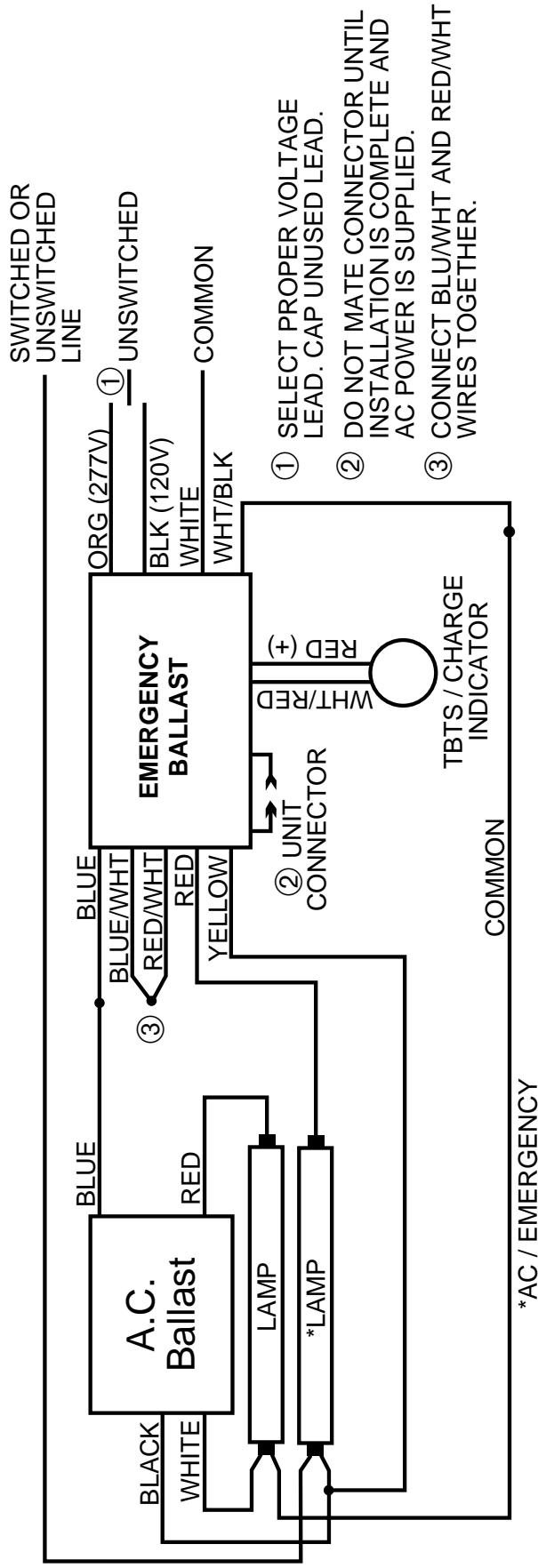

TWO LAMP INSTANT START BALLAST

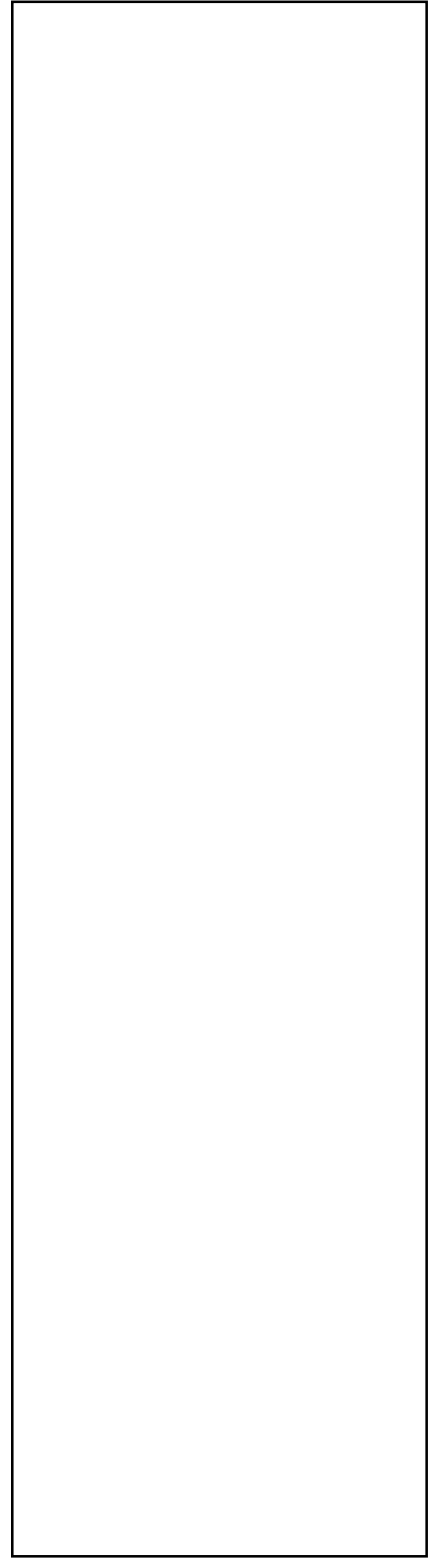
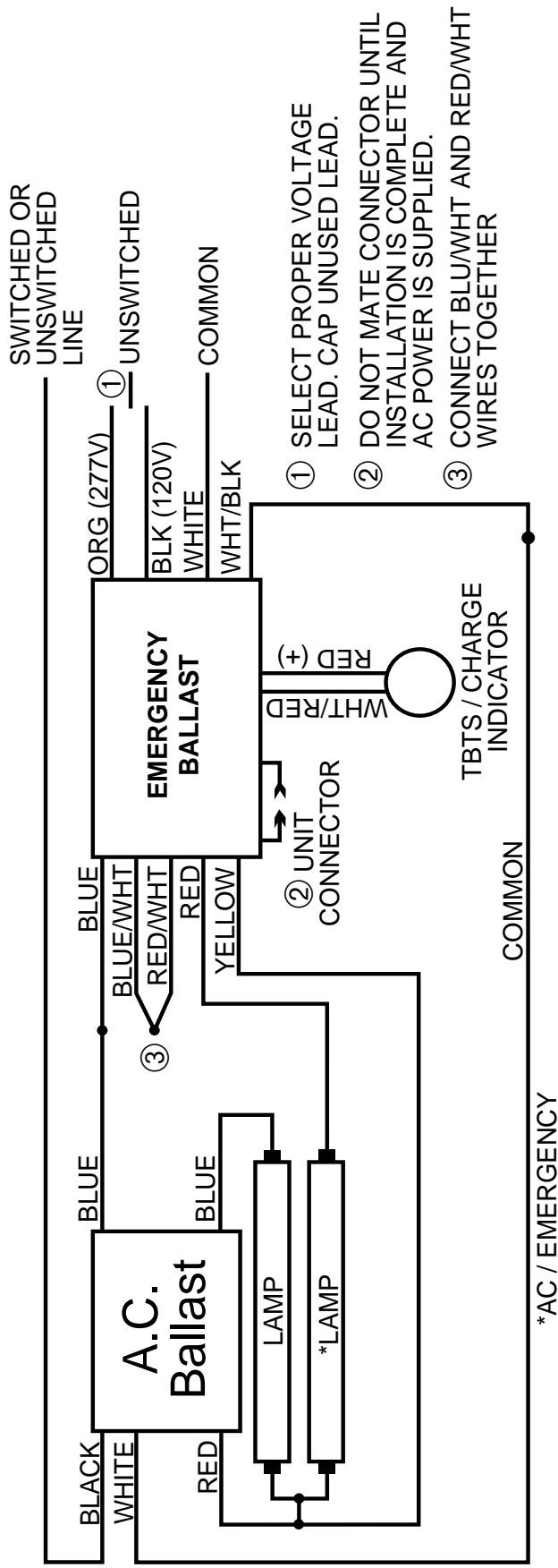

THREE LAMP INSTANT START BALLAST

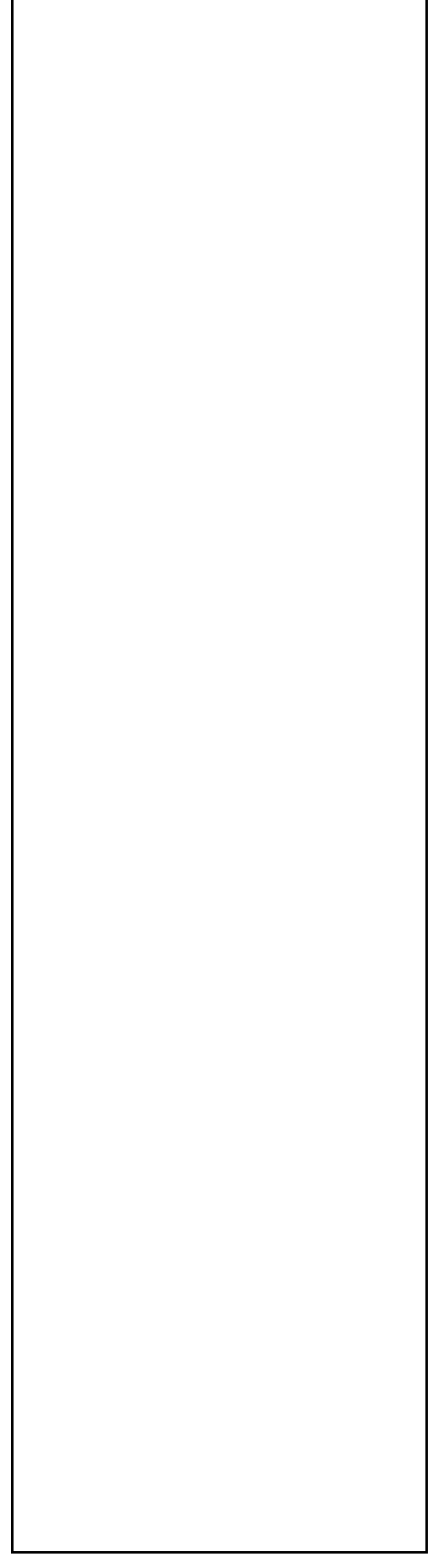
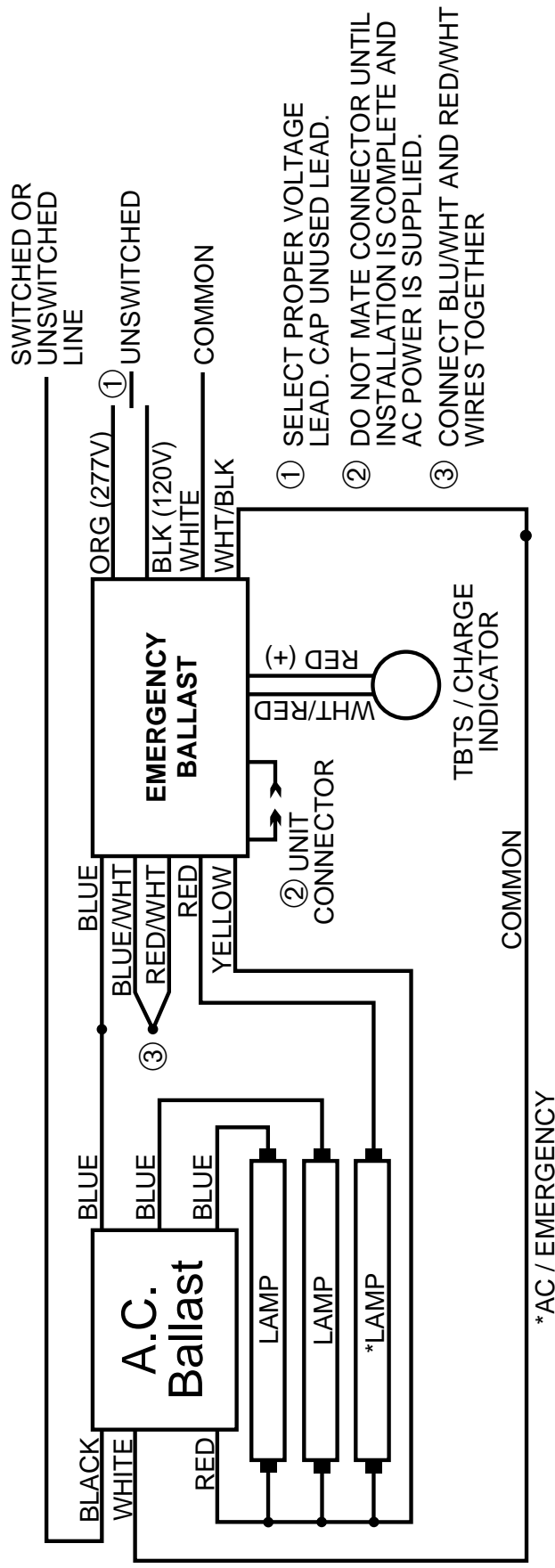

FOUR LAMP INSTANT START BALLAST

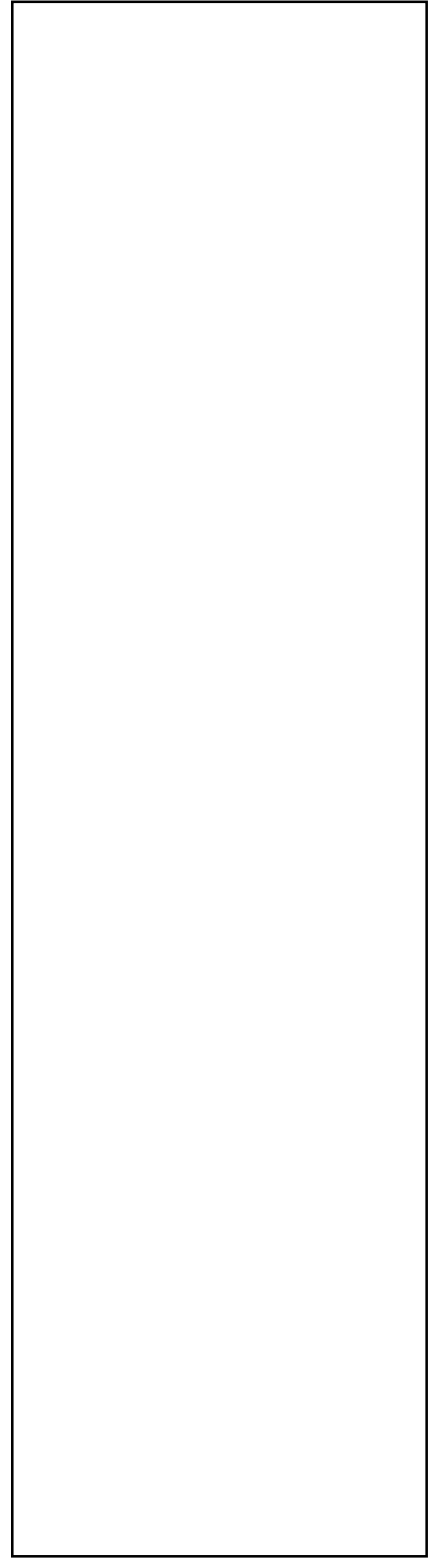
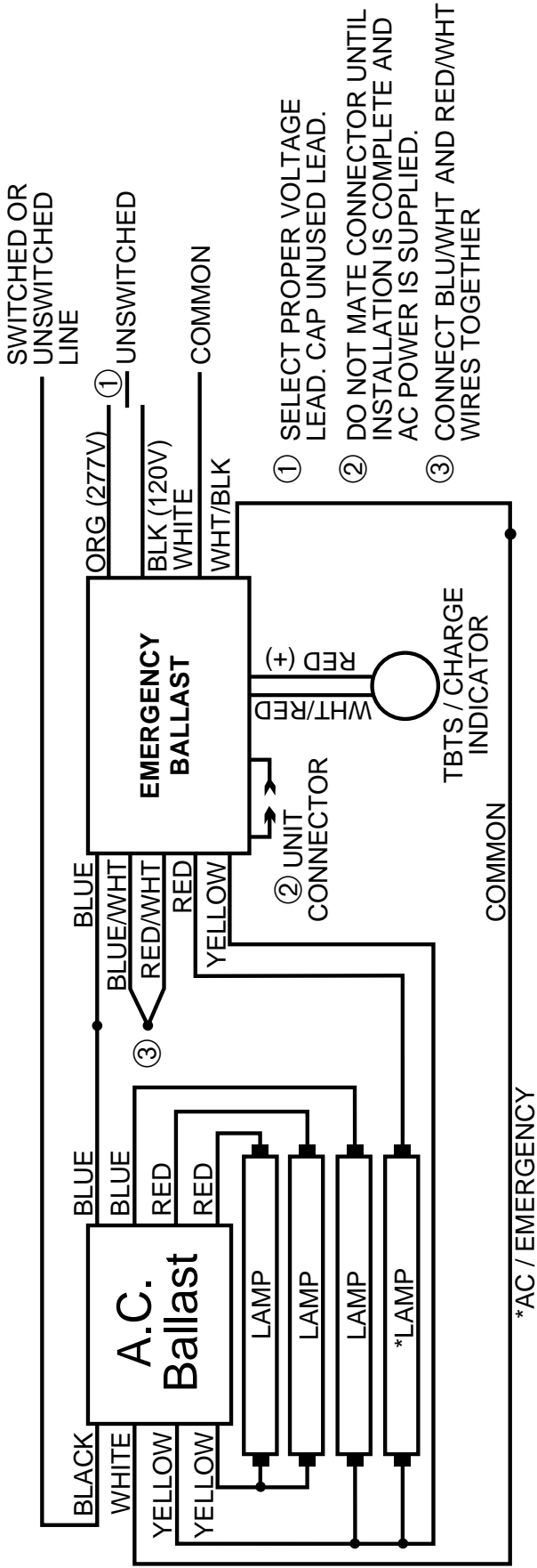

1LISB_ISL_2

ONE LAMP INSTANT START BALLAST

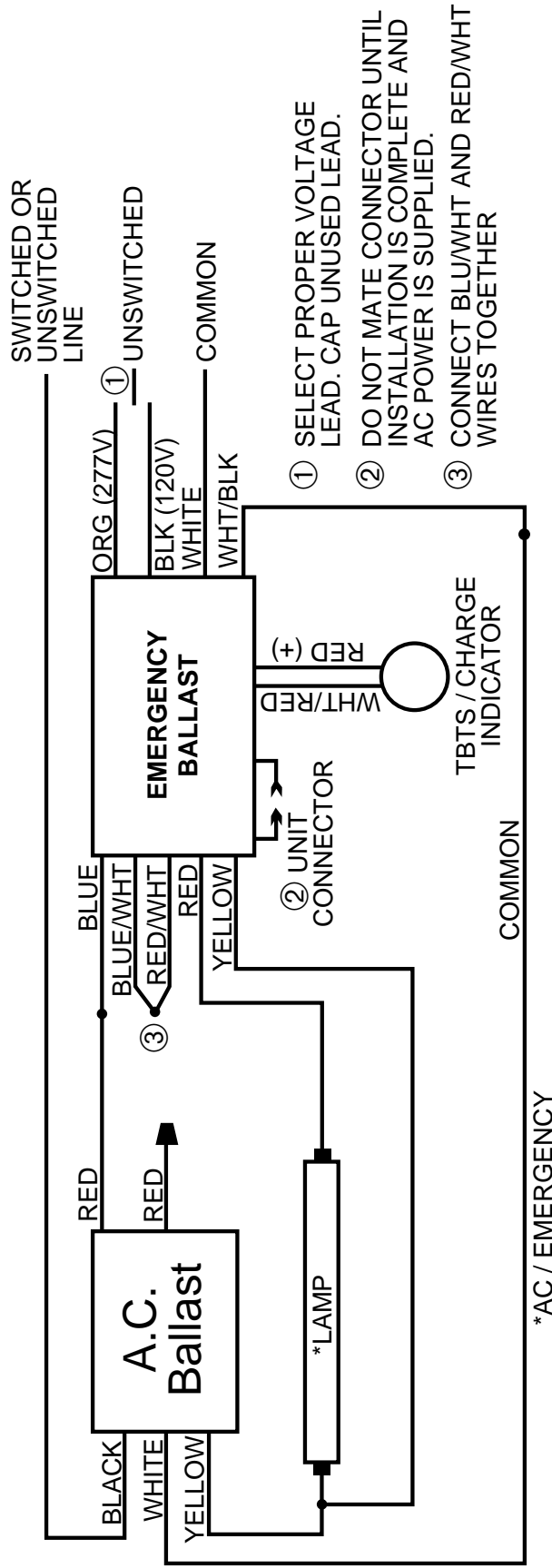

FULLHAM
WORKHORSE 2

4LR5B_ISL

FOUR LAMP RAPID START BALLAST

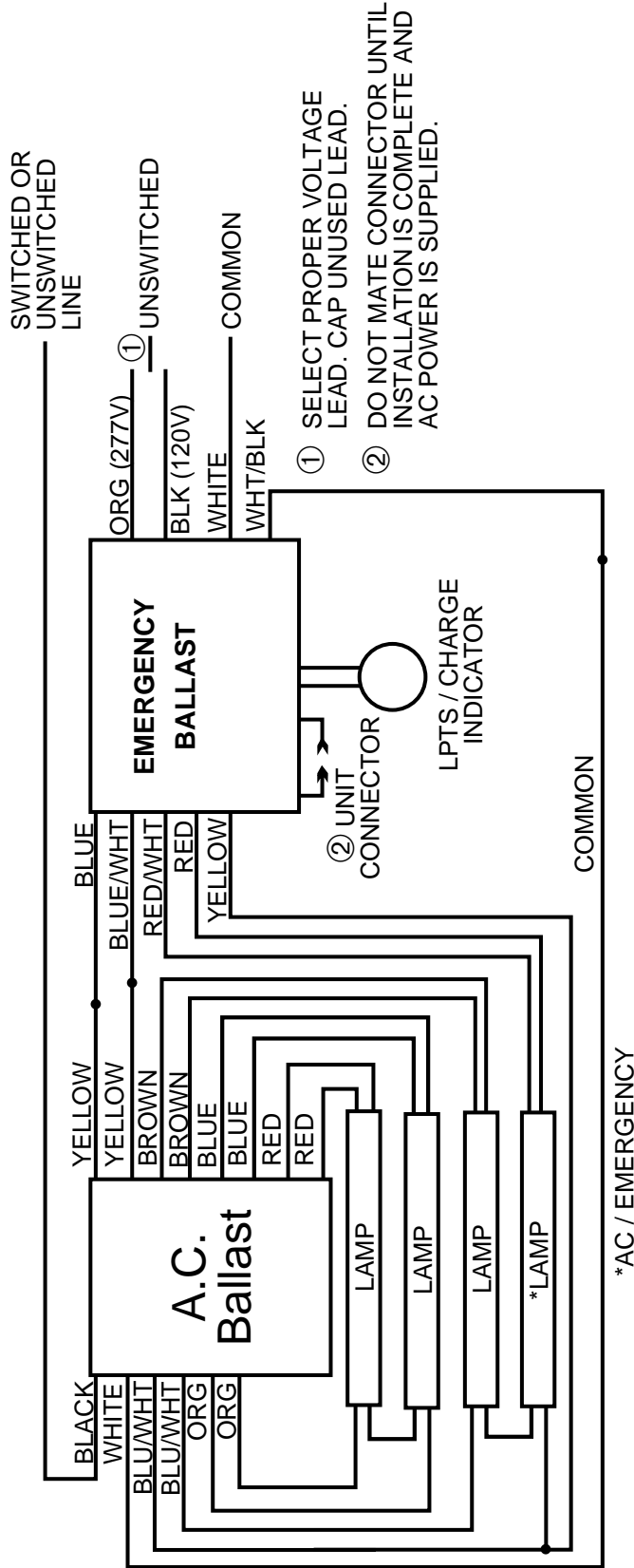

CENTIUM
 ICN 4S54 90C-2LS

ALL COMPATIBLE BALLASTS MAY NOT BE LISTED.
 *DIMMING CONTROL WIRES ARE NOT AFFECTED BY EM PACK

THREE LAMP RAPID START BALLAST

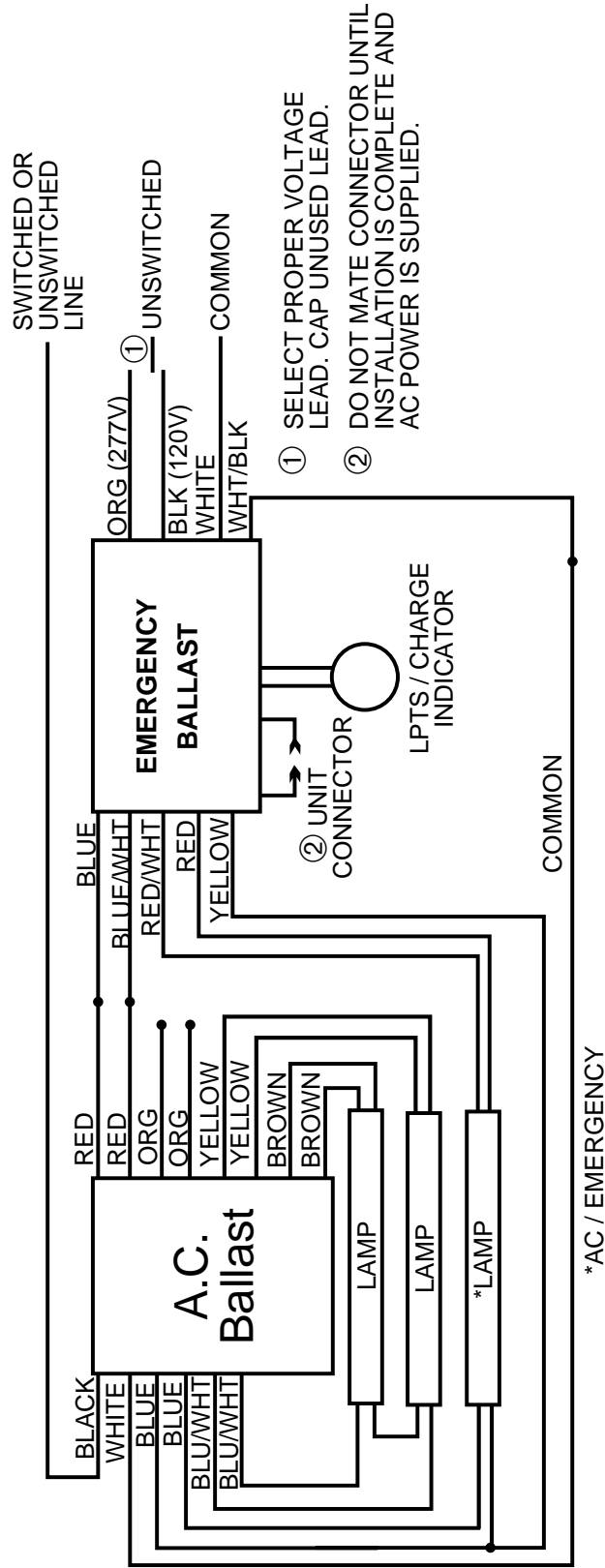

ADVANCE

ICN-4554-90C-2LS

ALL COMPATIBLE BALLASTS MAY NOT BE LISTED.
*DIMMING CONTROL WIRES ARE NOT AFFECTED BY EM PACK

2LISFB_ISL

TWO LAMP INSTANT START FULLHAM BALLAST

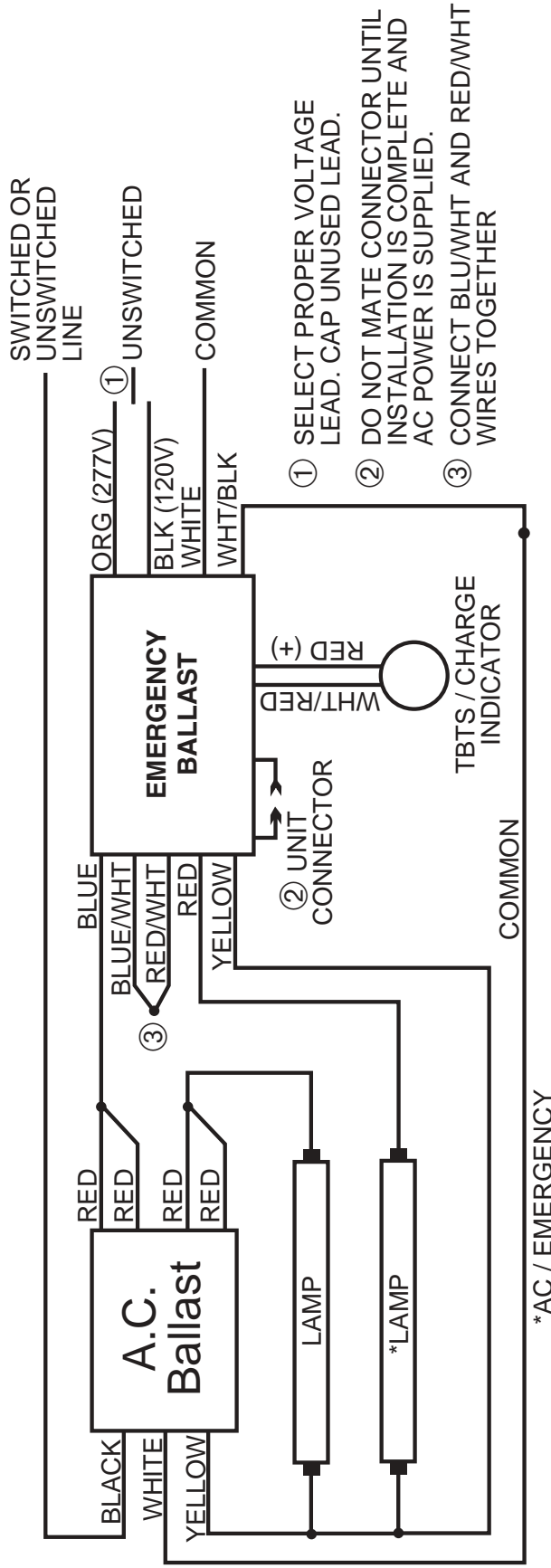

FULLHAM
WORKHORSE 5

2LRSB_SP_ISL

SUNPARK TWO LAMP RAPID START BALLAST

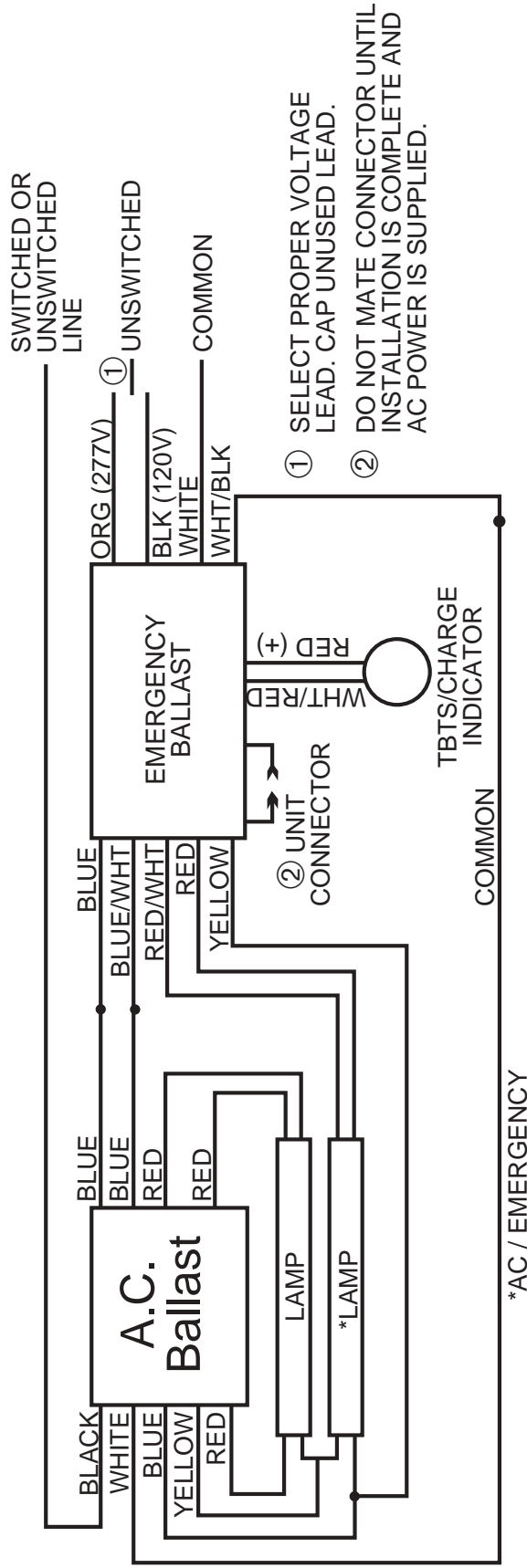

SUNPARK
SLI5P

2LRSBDUAL_ISL

TWO LAMP RAPID START BALLAST

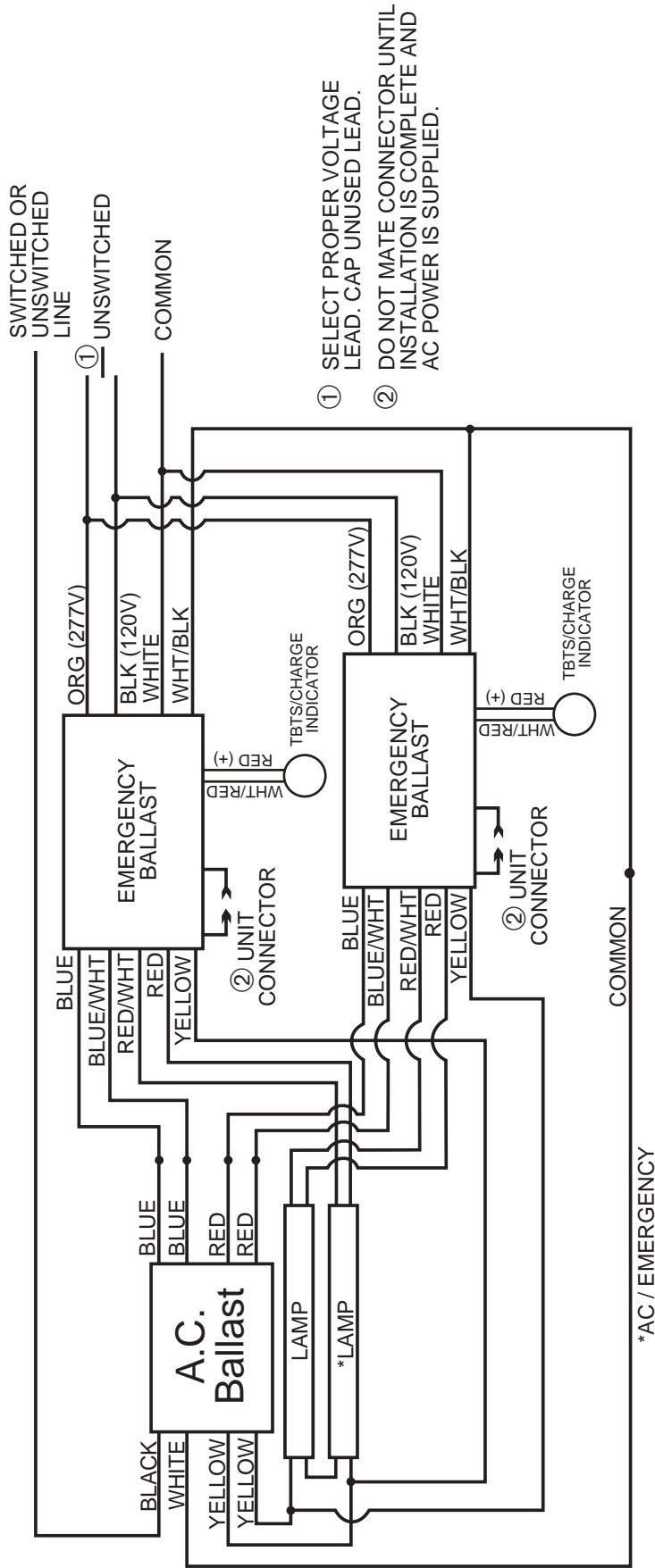

UNIVERSAL TRIAD

B254 PUV-D

ALL COMPATIBLE BALLASTS MAY NOT BE LISTED.
 *DIMMING CONTROL WIRES ARE NOT AFFECTED BY EM PACK