

LMIU 1000W Mini Inverter INTERRUPTIBLE EMERGENCY LIGHTING UNIT INVERTER INSTRUCTION MANUAL

IMPORTANT SAFEGUARDS

When using electrical equipment, basic safety precautions should always be followed, including the following:

READ THIS MANUAL AND FOLLOW ALL SAFETY INSTRUCTIONS THOROUGHLY BEFORE OPERATING THE LMIU INVERTER SYSTEM

i BEFORE CONTACTING TECHNICAL SUPPORT MAKE SURE TO FOLLOW ALL STEPS IN SEQUENCE AND REFER TO THE TROUBLESHOOTING GUIDE INCLUDED IN THIS MANUAL.

SAVE THESE INSTRUCTIONS

1. DO NOT USE OUTDOORS.
2. All unused wires must be capped to prevent shorting.
3. Do not mount near gas or electric heaters.
4. Do not let power supply cords touch hot surfaces.
5. Do not use this equipment for other than its intended use.
6. The **LMIU** should be mounted securely and in locations and at heights where it will not be readily subjected to tampering by unauthorized personnel.
7. The use of accessory equipment and replacement parts not recommended by manufacturer may cause an unsafe condition and void the warranty.
8. The AC voltage rating of this equipment is specified on the product label. Do not connect the **LMIU** equipment to any other voltage.
9. Replacement fuse is supplied.
10. The **LMIU** uses sealed valve regulated lead acid batteries. Batteries can be punctured if not handled properly, therefore use caution when servicing batteries. In the event battery acid comes in contact with eyes or skin, flush with fresh water and consult a physician immediately.
11. Install in accordance with the National Electrical Code and local regulations.
12. The **LMIU** contains potentially hazardous voltages. Installation, maintenance and service work should be performed by qualified and trained personnel.
13. Electricians and end-users need to ensure product system compatibility before final installation.
14. Units to be installed only as per configuration described in this instruction manual.

MODEL NUMBER	AC SPECS		EMERGENCY POWER AVAILABLE FOR LOAD				APPROX. WEIGHT
			90 MIN	2H	3H	4H	
LMIU-1000	120/277 VAC, 60Hz	12.8 / 5.3 Amps	1000W	807W	604W	489W	420lbs.

NOTE: At 120Vac, unit is rated at power factor 0.8. For loads having a power factor below 0.8, unit capacity needs to be derated. At 277Vac, unit is rated at unity power factor. For loads having a power factor below 1, unit capacity needs to be derated.

WARRANTY

All LightAlarms inverter products receive 100% quality inspection before shipment to ensure proper and satisfactory operation. When operated under normal conditions, LightAlarms inverter products will provide years of dependable service. This unit is backed by a 3-7 year warranty. The unit is covered by a complete 3-year warranty against defects in material or workmanship, and a 7-year pro-rata battery warranty.

 **WARNING:** DO NOT ENERGIZE THE CIRCUIT UNTIL ALL STEPS HAVE BEEN SUCCESSFULLY COMPLETED.

 **WARNING:** ALWAYS TURN OFF THE INVERTER MODULE AND THE AC SUPPLY TO THE EQUIPMENT AND DISCONNECT THE BATTERY BEFORE SERVICING. ONLY QUALIFIED SERVICE TECHNICIANS SHOULD SERVICE THIS EQUIPMENT. THE USE OF PARTS SUPPLIED BY OTHER THAN THE MANUFACTURER MAY RESULT IN AN UNSAFE CONDITION OR EQUIPMENT FAILURE AND WILL VOID THE WARRANTY.

 **WARNING:** THE MINI INVERTER MUST BE MOUNTED SECURELY USING A 1/4" (MIN) SCREW AND FLAT WASHER FOR EVERY KEYHOLE. THE MOUNTING SURFACE MUST ALSO BE SUFFICIENTLY REINFORCED TO ACCOMMODATE THE WEIGHT LISTED (SEE PAGE 1). FAILURE TO SECURE THE UNIT SUFFICIENTLY CAN DAMAGE THE EQUIPMENT AND/OR CAUSE SERIOUS INJURY.

 **WARNING:** DO NOT CONNECT THE BATTERY(IES) UNTIL YOU ARE PREPARED TO START-UP THE UNIT PERMANENTLY. CONNECTING THE BATTERIES WITH THE UNIT OFF FOR A PROLONGED PERIOD MAY DRAIN THE BATTERIES TO THE POINT THAT YOU WILL NOT BE ABLE TO START-UP THE UNIT.

 **WARNING:** FAILURE TO CONNECT THE BATTERIES PROPERLY MAY RESULT IN EQUIPMENT FAILURE OR AN UNSAFE CONDITION AND WILL VOID THE WARRANTY. A SMALL SPARK MAY OCCUR WHEN CONNECTING TO THE BATTERY WIRES. THIS IS NORMAL AND IS CAUSED BY LARGE CAPACITORS CONTAINED IN THE MINI INVERTER BEING CHARGED.

 **CAUTION:** BEFORE INSTALLING, MAKE CERTAIN THE A.C. POWER IS OFF. NOTE: THE BATTERIES ARE SHIPPED SEPARATELY. PLACE THEM IN A LOCATION AWAY FROM THE WORK AREA TO AVOID DAMAGE UNTIL THEY ARE TO BE INSTALLED.

 **CAUTION:** THIS UNIT PROVIDES MORE THAN ONE POWER SUPPLY OUTPUT SOURCE. TO REDUCE THE RISK OF ELECTRICAL SHOCK WHEN SERVICING, DISCONNECT BOTH NORMAL AND EMERGENCY SOURCES BY TURNING OFF THE A.C. BRANCH CIRCUIT AND BY DISCONNECTING THE BATTERY.

 **CAUTION:** ONLY ONE VOLTAGE IS ALLOWED (120V OR 277V). CONNECTION TO MORE THAN ONE VOLTAGE MAY RESULT IN EQUIPMENT FAILURE AND VOID THE WARRANTY.

 **CAUTION:** FOR NORMALLY ON UN-SWITCHED UNITS: THE JUMPER WIRE IS PRESET FOR 120VAC. IF THE UNIT IS TO BE WIRED FOR 277VAC, REMOVE THE JUMPER WIRE FROM THE 120VAC INPUT POWER TERMINALS AND REINSTALL THE JUMPER WIRE INTO THE 277VAC INPUT POWER TERMINALS.

 **CAUTION:** IF CONNECTED TO 277V INPUT, USE A 277V RATED SWITCH. FAILURE TO USE THE PROPER VOLTAGE SWITCH MAY RESULT IN SWITCH FAILURE, A SHOCK HAZARD, AN UNSAFE CONDITION AND/OR EQUIPMENT FAILURE.

 **IMPORTANT:** FOLLOW THE APPROPRIATE WIRING DIAGRAMS. DO NOT CONNECT THE "INPUT POWER" NEUTRAL TO THE "LOAD" NEUTRAL. FAILURE TO COMPLY WITH THIS DIRECTIVE MAY RESULT IN EQUIPMENT FAILURE AND VOID THE WARRANTY.

 **IMPORTANT:** FOR NORMALLY OFF LOAD: REMOVE THE JUMPER WIRE BEFORE WIRING THE UNIT.

INSTALLATION

STEP 1: MOUNTING THE MINI INVERTER TO WALL (SEE FIGURE 1A)

- Remove the front cover of the Mini Inverter cabinets by removing the two screws located on the front of the cover.
- Extend the unswitched, properly-rated AC voltage supply and remote fixture wires to the installation area.
- Mount the battery cabinet securely to the wall using the keyhole slots located at the rear of the cabinet. Leave a minimum of 36 inches above the battery cabinet for the electronic cabinet. It is recommended to safely support the cabinet during installation.
- Place the electronic cabinet on top of the battery cabinet and align the four bolt/nut assemblies to the holes located on top of the battery cabinet.
- Install and tighten the lock washers and nuts onto the bolts inside the battery cabinet.
- Secure the electronic cabinet to the wall using the keyhole slots located at the rear of the cabinet.
- The recommended clearance is 3.5 inches on either side of the Mini Inverter and 42 inches on the front. No clearance is required on the top or bottom of the assembled unit.
- Route the blue and red wires through the two holes located at the bottom of the electronic cabinet to the battery cabinet.
- Connect the conduit containing the AC supply and remote fixture leads to the electronic cabinet. Use the provided knock-outs on the side of the electronic cabinet to connect the incoming wires.
- Install the batteries, but **DO NOT** connect the battery leads at this point until other wiring is completed.
- Route the ground (green wire) from the electronic cabinet to the battery cabinet. Bolt the ground wire to the battery cabinet using the nut and bolt provided.

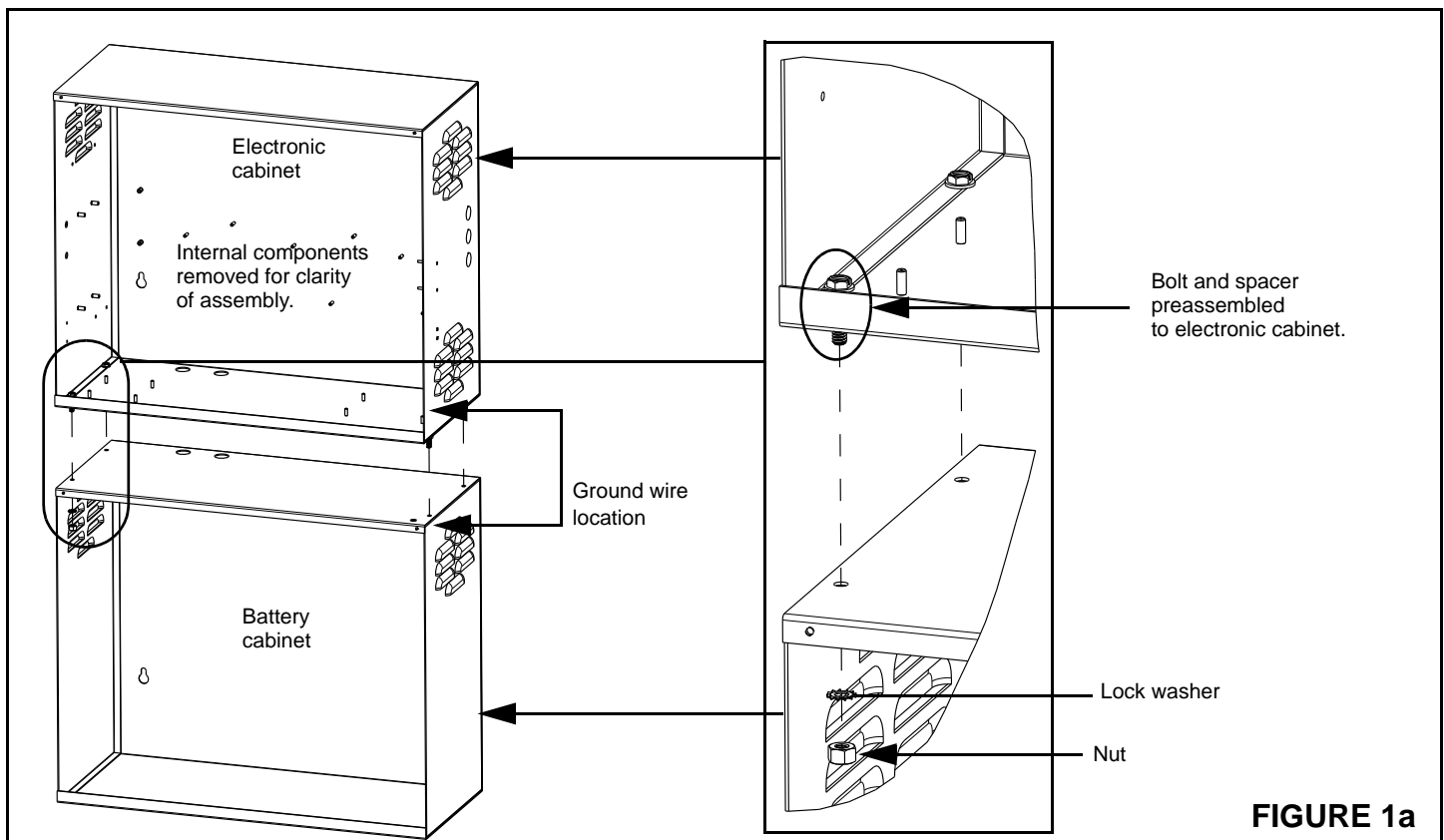

FIGURE 1a

STEP 2: CONNECT NORMAL AC INPUT (SEE FIGURE 2B)

- For 120V supply, connect the AC Line wire to the 120V (UN-SWT) position of the INPUT POWER section of the terminal block. For 277V supply, connect the AC Line wire to the 277V (UN-SWT) position of the INPUT POWER section of the terminal block.
- Connect the NEUTRAL wire to the NEUTRAL position of the INPUT POWER section of the terminal block.
- Connect the ground wire in accordance with local and national codes.
- For Nexus wired (option): Refer to the "WIRING FOR NEXUS®" on the page 5.

STEP 3: CONNECT REMOTE EMERGENCY FIXTURES (SEE FIGURE 2A, 2B, 2C OR 2D)

- Connect the remote emergency fixtures to the correct position of the LOAD terminal block by respecting the operating voltage. All remote circuitry is to be wired in accordance with Article 700 of the National Electric Code.
Do not exceed the total rating of the Mini Inverter.
 - At 120Vac, unit is rated at power factor 0.8. For loads having a power factor below 0.8, unit capacity needs to be derated.
 - At 277Vac, unit is rated at unity power factor. For loads having a power factor below 1, unit capacity needs to be derated.
 - Special attention shall be taken when load consists of LED lamps with no built-in power factor correction. Example: most of the single LED lamps (Screw-on, GU-10, etc.) have a power factor of less than 0.6. This translates to a derating close to 50%.
- NORMALLY-OFF LOAD (only turn on during power failure)** - Remove the jumper wire. Connect the AC Line input wire of the fixtures to the appropriate position of the LOAD terminal block (120V OR 277V). Connect the fixture Neutral to the Neutral position of the LOAD terminal block. Refer to Figure 2B.
- UNSWITCHED NORMALLY-ON LOAD** - Connect the AC Line input wire of the fixtures to the appropriate position of the LOAD terminal block (120V OR 277V). Connect the fixture Neutral to the Neutral position of the LOAD terminal block. Refer to Figure 2C.
- SWITCHED NORMALLY-ON LOAD** - (fixtures may be turned on and off locally, but will come on during power failure regardless of switched position) - Follow Step 3B above. Connect the Line side of the switch to the (UN-SWT) position of the INPUT POWER terminal block by respecting the operating voltage (120V OR 277V). Connect the load side of the switch to the (SWT) position on the INPUT POWER terminal block by respecting the operating voltage (120V OR 277V). Refer to Figure 2A.
- Connect the Fixture Supply Ground to the Mini Inverter Ground.

STEP 4: CONNECT BATTERIES (SEE FIGURE 1b)

- Position the batteries in the battery cabinet as shown in figure 1b. Make sure to respect the battery polarities
- The battery assembly consists of two battery strings, 24Vdc nominal each. Each battery string consists of two 12V batteries connected in series. In figure 1b, "Battery 1" and "Battery 2" form the first string. "Battery 3" and "Battery 4" form the second string. The two 24V battery strings are connected in parallel.
- Route the RED(positive) and BLUE(negative) battery cables plus the thin yellow cable (AWG#22) from the electronic cabinet to the battery cabinet.
- Start by connecting the battery interconnect cables **ALONG WITH THE THIN YELLOW CABLE (AWG# 22)**.
- Measure the DC voltage between the yellow cable and the main negative terminal of the battery bank. Confirm this voltage is between 12V and 13V.
- Connect the BLUE(negative) cable routed from the electronic cabinet to the main negative terminal of the battery bank.
- Measure the DC voltage between the main positive terminal and the main negative terminal of the battery bank. Confirm this voltage is between 24V and 26V. In case the measured voltage is different, verify the battery wiring.
- Connect the RED(positive) cable routed from the electronic cabinet to the main positive terminal of the battery bank.
- Tighten all bolts to a recommended torque of **78 lbf-in ± 4 lbf-in**.

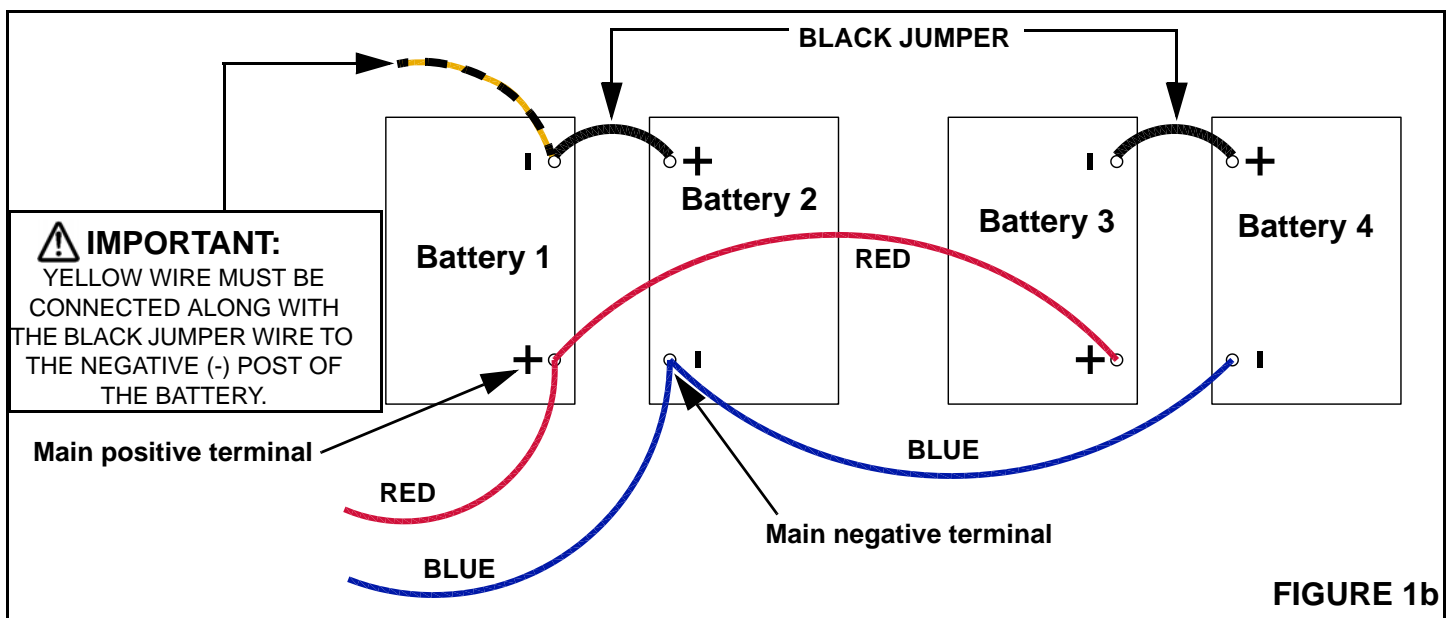

STEP 5: SWITCH ON INVERTER MODULE (SWITCH IS LOCATED ON THE RIGHT SIDE OF THE INVERTER MODULE).

NOTE: THE EMERGENCY LIGHT AND INDICATORS WILL NOT TURN ON AT THIS TIME.

STEP 6: COMPLETE THE INSTALLATION

- a. Energize the AC supply. The Status Indicator will illuminate. Refer to the operation information below for more information about the Status Indicator.
- b. Normally-ON fixtures shall be ON, Normally-OFF shall be OFF. Switched Emergency Fixtures shall be ON only when the switch is in the ON position.
- c. Manually test the unit by pressing the test switch for 1 second and then release it. (Refer to "MANUAL TEST" below).
- d. If status LED is not green, reset the system. (Refer to "SYSTEM RESET" below).
- e. Properly re-install all the covers of the Mini Inverter using all the original hardware.

NEXUS[®] (OPTION)

Wired:

- a. Route the NEXUS[®] data cables in the unit and strip one inch (25mm) of the double insulation. The two cables are identical and both contain 2 wires of different colors: color A and color B.
- b. Gather the color A wire from each cable, and connect them to the same pole on the terminal block. Gather the color B wire from each cable, and connect them to the other pole on the terminal block. The result must be 2 wires of the same color connected to each pole on the terminal block. See Figure on side.
- c. Leave a minimum of one inch (25mm) between the live voltage cabling and the unsheathed low voltage data cabling.

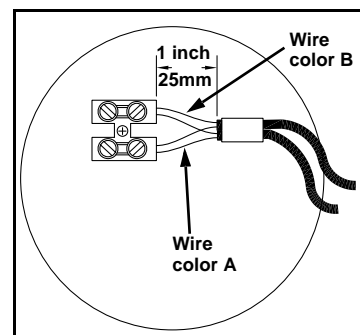

Wireless:

NO WIRING IS REQUIRED FOR THE NEXUS[®] WIRELESS VERSION.

See addendums: 750.1532 and 750.1641 for more information and antenna installation.

MANUAL TEST

Press the test switch for 1 second and release to initiate a 1 minute manual test. The Status Indicator will start flashing green. All normally-ON lamps (switched or unswitched) will turn ON. All normally-off lamps shall also be ON. After 1 minute, the test will stop and all lamps will revert to their normal operating mode.

At the end of the 1-minute test, the unit will revert to recharge mode. The status indicator will be steady ON green if no fault has been detected. If a fault is detected, please refer to the FEATURES AND OPTIONS instructions on pages 8-9 for more details on the diagnostics and auto test features.

Allow the batteries to charge for a minimum of 48 hours after installation or power failure before conducting a 90-minute discharge test. The Life Safety Code and the Authorities Having Jurisdiction require that the 90-minute discharge test be performed on an annual basis.

SYSTEM RESET

Resetting the system:

Depending on the sequence of installation, some units may require a system reset. To reset the system, press the test switch-located on the left side of the unit for 6 seconds.

MAINTENANCE

BATTERY: The batteries supplied in this equipment are high quality maintenance-free Valve Regulated Lead Acid design.

They require no maintenance and, when installed in an ambient temperature of 25° C (77° F), their life expectancy is 8 to 10 years.

Equipment must be tested for a minimum of 90 minutes annually. When the batteries will no longer operate the load for 90 minutes, they must be replaced. Replace only with manufacturer supplied parts.

Properly dispose of or recycle the Lead-Acid battery.

**NOTE: WIRING DIAGRAMS HAVE BEEN SIMPLIFIED FOR CLARITY.
ACTUAL POSITION OF COMPONENTS MAY VARY.**

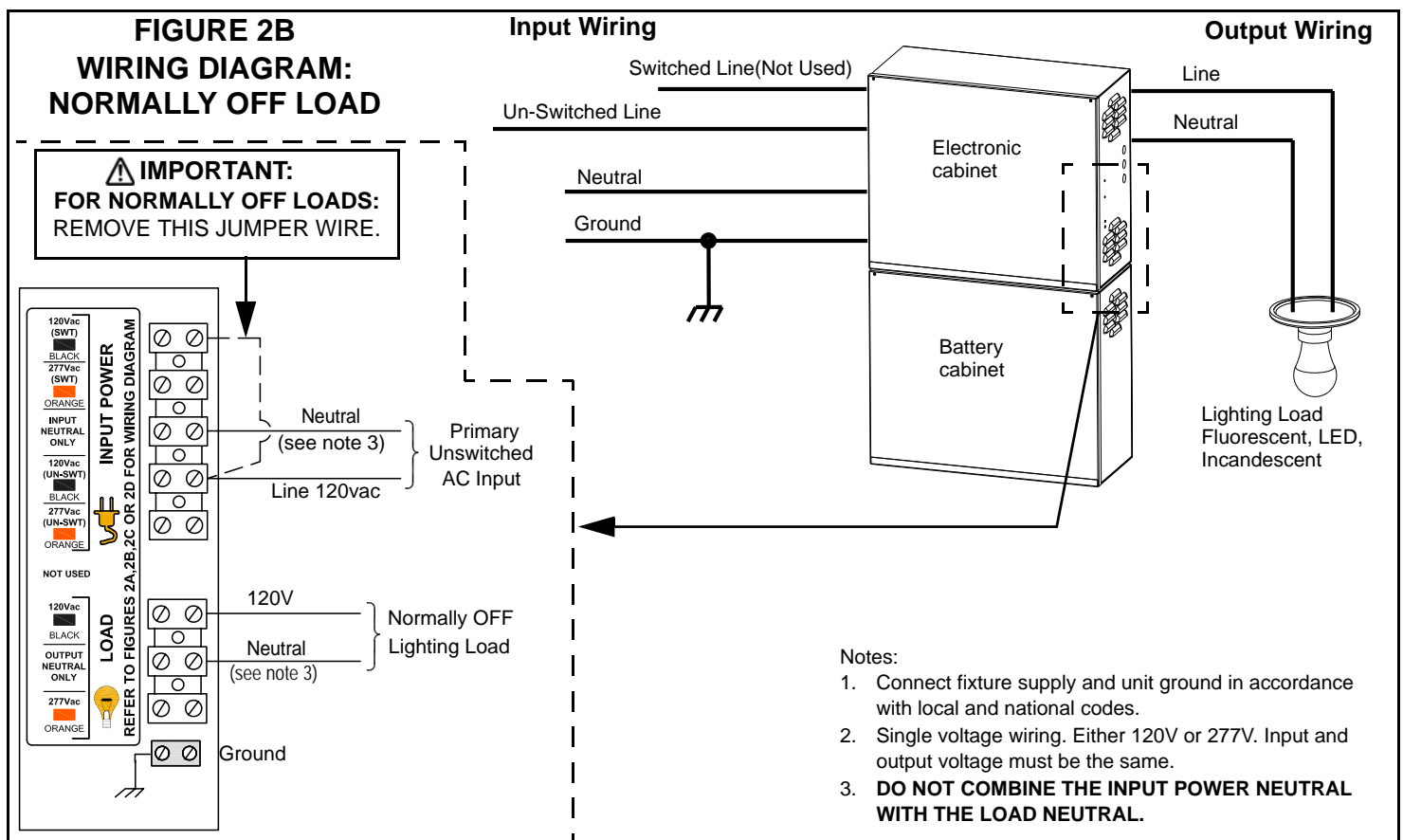
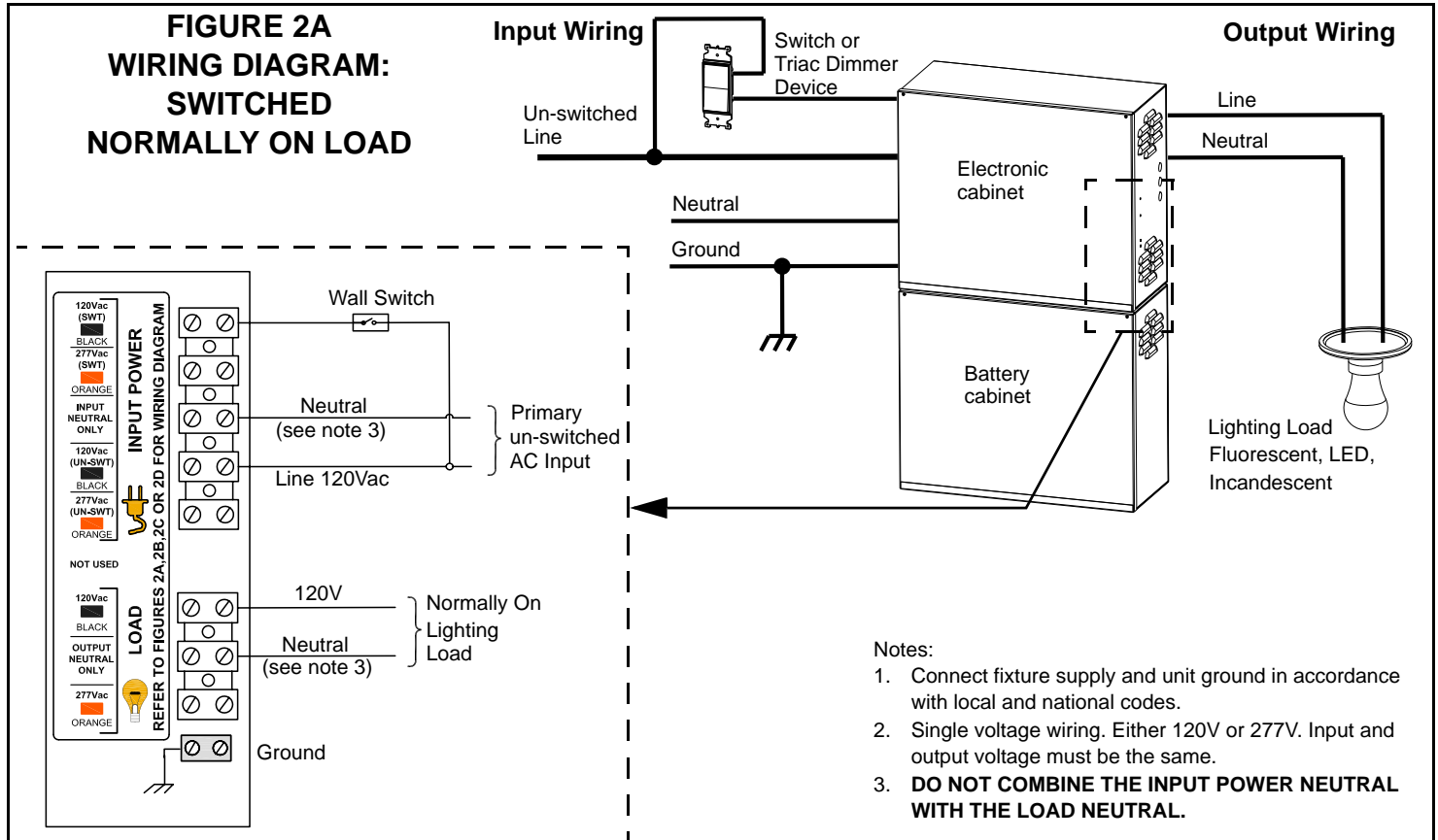

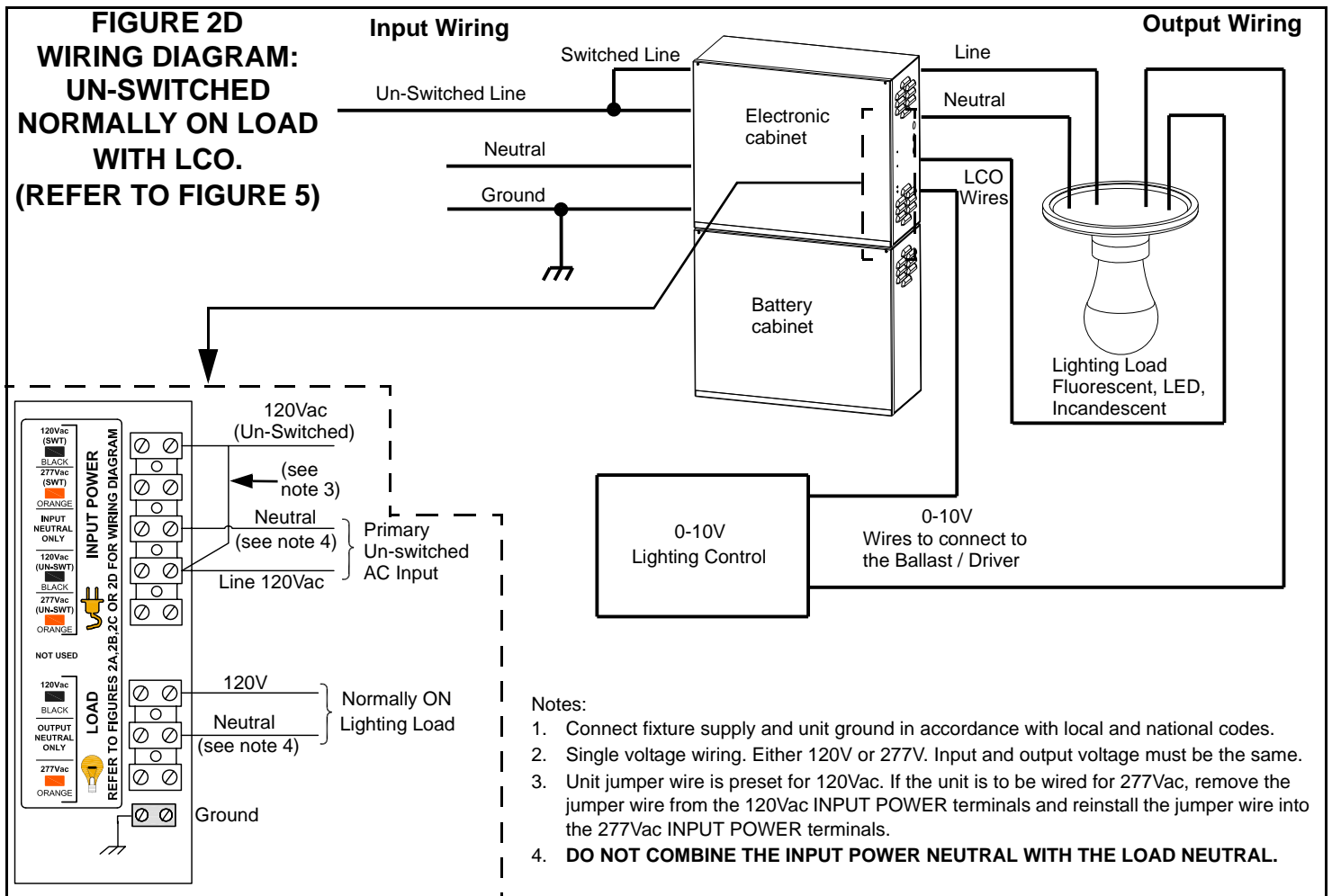
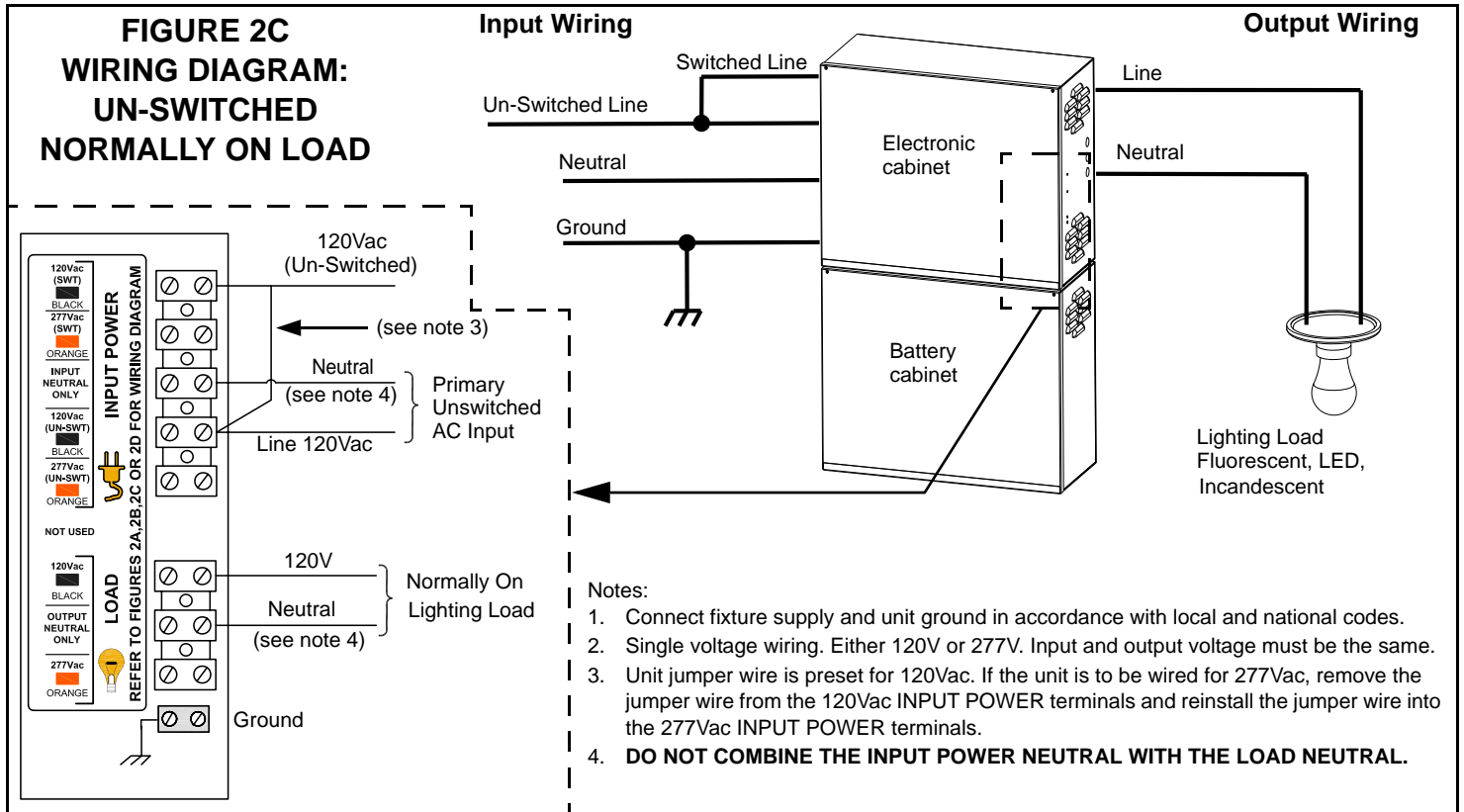

FEATURES AND OPTIONS

SYSTEM OPERATION

- The diagnostic/charger is a self-contained, fully automatic microcontroller-based system.
- When installation is complete, only the battery connection is needed. AC power needs not be energized.

The unit goes directly into lockout mode and waits for AC power to be restored.

See warning on page 2.

1. ALARM SILENCE / MANUAL TEST / SYSTEM INITIALIZATION

- Alarms are silenced by pushing the “TEST” switch less than one half second. Alarm indication can only be silenced after correcting the fault or by re-initializing the system.
- Press the test switch for 1 second and release to initiate a 1 minute manual test
- System initialization is done by holding the “TEST” switch for at least 6 seconds.

2. DIAGNOSTIC AND NEXUS® (OPTION)

If the audible alarm has been activated, any fault condition will produce an audible warning that consists of an intermittent beep: one second on, one second off.

See figure 3 for possible conditions.

a. BATTERY DISCONNECT / INVERTER FAILURE

The status indicator displays steady red LED if the battery circuit is open or shorted, or if there is an Inverter failure.

b. BATTERY FAILURE

1 red blink and a pause of 5 seconds: incorrect battery (e.g. 12V battery on a 6V system), or battery has failed a timed or forced test (reached LVD level before the end of the test).

c. CHARGER MONITORING

2 red blinks and a pause of 4 seconds: charging current is not within limits corresponding to charger command state.

d. LIGHTING LOAD CAPTURE SEQUENCE

Only initiated by a reset of the system. Press “TEST” switch for at least 6 seconds. Reset initializes the main counter. This renewal takes place to compensate for system variations when the unit ages. Renewal is not allowed if there is a lighting load failure alarm. This is not applicable for units with no auto-test option.

e. SERVER FAILURE

The Nexus server (controller or PC) is no longer communicating with the RF unit’s modem. Verify Nexus server is up and running. If it is up and running, check whether other surrounding emergency lighting units are not powered. If surrounding emergency lighting units are powered off the surrounding emergency lighting units will prevent the unit in question to communicate with the modem. Otherwise reset the modem.

f. BLINK MODE

A “Blink mode” signal was sent from the Nexus server (controller or PC) to the emergency lighting unit. To stop the “Blink mode”, you need to access the Nexus server and execute a stop blink mode operation.

g. NOT COMMISSIONED

The unit is not registered in the Nexus server. Commission the unit. The auto-test will be disabled and the LED will show a steady green for 10 seconds and steady orange for 1 second.

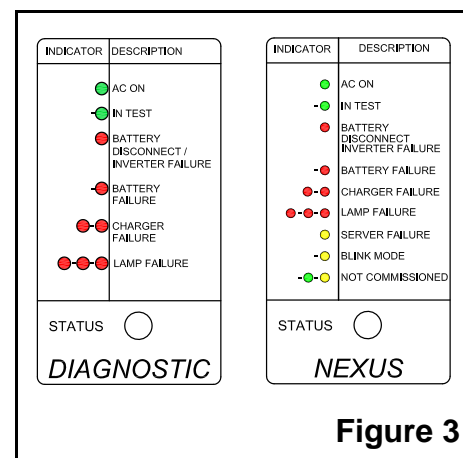

Figure 3

To cancel a fault alarm display, reset unit after issue correction.

*Refer to Nexus® installation addendum for more details.

⚠ IMPORTANT: Reset the system for each addition or change of lighting load. Press the test switch for 6 seconds in order to reset the system.

3. AUTOMATIC UNIT TEST (30-DAY TEST)

Every 30 days, while in charging mode, the sequence generator will generate a command to energize the transfer on the emergency lighting circuit for a variable test period depending on the yearly sequence.

	US (MIN)
Monthly test	1
6 month test	30
12 month test	90

i NOTE: AUTO-TESTING IS NOT PROVIDED IN SOME UNITS. REFER TO FEATURE 8.

- If the battery fails to complete the discharge test, the charger will display a battery failure and the test will abort.
- The 30-day automatic test sequence is reset every time the lighting load is turned on, including after a manual test.

4. LIGHTING LOAD TESTING

The test is fully automatic. To maintain accurate data, these 2 conditions must be met prior to acquiring values from a connected and functional lighting load:

- The battery has to be at or near full power. The program will delay data capture for a minimum of 48 hours following any discharge or reset.
- The charger will also wait to be in hysteresis mode (charger cycling on/off).

⚠ IMPORTANT: Must install a minimum lamp load equivalent to 10% of the rated capacity of the unit.
Example: 100W for a 1000W inverter unit.

5. AUDIBLE ALARM (BUZZER)

This option can be activated or de-activated in the field. Refer to Figure 4.

To select the audible alarm option:

- Remove all power sources to the board (AC and battery).
- With long-nose pliers, pull on the shunt (little black box) until it is free from the pins.
- Put the shunt back in place according to the option selection.
- Reconnect AC power and the battery.

6. SERVICE ALARM CONTACT (OPTION)

If installed, insert each wire of the Building Alarm Panel into separate terminals of the terminal block marked "SERVICE ALARM".

Alarm Panel shall provide a 24V signal. The charger board will indicate a fault by closing a contact. Polarity is not specified.

7. LIGHTING CONTROL OVERRIDE

This feature is used with lighting loads equipped with low voltage dimming control. The dimming function must be disabled during a power failure in order for the load to provide a 100% level of lighting.

The circuit consists of a single-pole dry-contact relay that is normally closed in stand-by operation. In emergency mode (power failure) the relay contacts open and disconnect the dimming signal from the lighting load, allowing the load to operate at 100% light level.

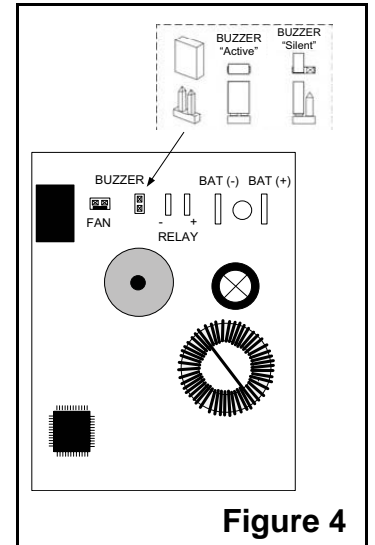

Figure 4

i IMPORTANT: Only one control signal can be handled by one LCO module. Multi control signals require one LCO per control signal. Consult customer service if there is more than one Lighting Control signal to be overridden.

INSTALLATION:

1. Locate the Lighting Control signal cable pair.
2. Cut, strip and extend one wire only, of the Lighting Control signal cable.
3. Connect to the terminal block marked "LIGHTING CONTROL OVERRIDE" as shown in the wiring diagram below.

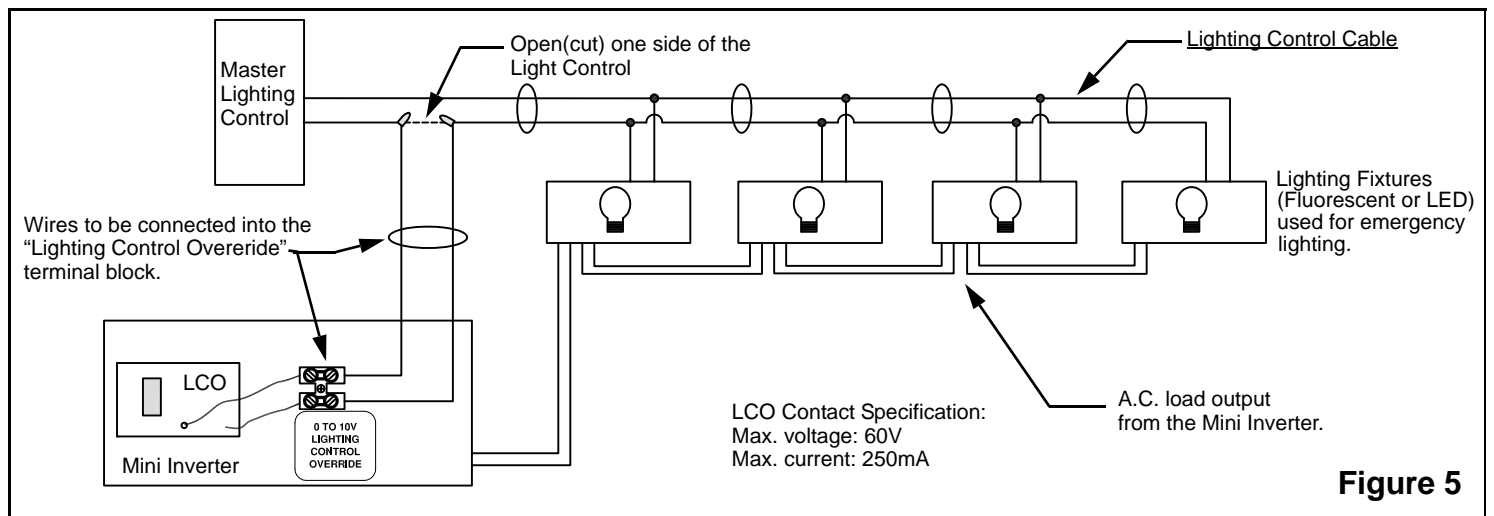



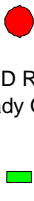



Figure 5





8. UNITS WITH NO AUTO-TEST (OPTION)

This equipment is not self-testing in conformance with the Life Safety Code, ANSI/NFPA 101.

TROUBLESHOOTING GUIDE (PAGE 1 OF 2)

STATUS INDICATOR (LED)	TROUBLESHOOTING GUIDE		
	SYMPTOMS	PROBLEM	CORRECTIVE ACTION
 <p>LED GREEN ON Steady, not flashing</p>	Lamp load is on	None if unit is in normally on mode	Unit is operating correctly
	Lamp load is off	None if unit is in normally off mode	Unit is operating correctly
	Lamp load is OFF, but the unit is in normally on mode	The fuses are burnt	Replace the fuses after verifying that there is no short circuit in the load
	-Lamp load is OFF (if installation is normally OFF) -Lamp load is ON (if installation is normally ON)	Power at primary AC input + battery discharged (at LVD) + no reaction with test button	- Remove the primary AC input + disconnect the battery + wait minimum 10 seconds - connect the battery + connect the primary AC input => the unit will restart - if the unit did not restart + call technical support.
 <p>LED flashing GREEN/ORANGE</p>	Lamp load is ON	None if unit is in normally on mode +Nexus option	Unit is operating correctly. Unit is not commissioned to the Nexus system
	Lamp load is OFF	None if unit is in normally off mode +Nexus option	Unit is operating correctly. Unit is not commissioned to the Nexus system
 <p>LED flashing GREEN/OFF</p>	Lamp load is ON	None the unit is in test mode or is sampling load	Unit is operating correctly
	Lamp load is OFF	The output fuse is burnt	Replace the fuses after verifying that there is no short circuit in the load
 <p>LED steady OFF, not flashing</p>	Lamp load is ON	No power at primary AC input + in emergency mode	Check the circuit breaker panel
	Lamp load is OFF	No power at primary AC input + emergency mode stop (battery discharged)	Check the circuit breaker panel
	-Lamp load is OFF (if installation is normally OFF) -Lamp load is ON (if installation is normally ON)	Power at primary AC input + battery discharged (at LVD) + no reaction with test button	- Remove the primary AC input + disconnect the battery + wait minimum 10 seconds - connect the battery + connect the primary AC input => the unit will restart - if the unit did not restart, call for technical support at 1-(888)-552-6467.
 <p>LED RED steady ON + GREEN LED on PCBA charger board steady ON</p>	Inverter Error	In emergency or in test, no output (Inverter switch OFF)	Check the inverter ON/OFF switch => Turn it on. Switch is located on the right end of the inverter module.
		In emergency or in test, no output (Inverter Failure)	Check the inverter control RJ12/RJ50 cable
		In emergency or in test, output OK (Inverter Sensing defect)	Check if the yellow wire is connected. Refer to figure 1.
		In emergency or in test, no output (Inverter Failure)	Reset the system(see page 4) and if the result is the same, replace the inverter module
		Over temperature in emergency or in test	- Verify if the LED Over Temp/Fault is ON on the inverter - Verify if fan is blocked or not working
		Over load in emergency or in test	- Verify if the LED Overload/Fault is ON on the inverter - Verify if too many loads are connected to the inverter
 <p>LED RED steady ON</p>	Battery Disconnect Error	No battery installed in the unit	Install the battery following the installation guide
		The 12V battery sensing not connected	Check if the yellow wire is connected. Refer to figure 1.

TROUBLESHOOTING GUIDE (PAGE 2 OF 2)

 LED Flashing RED 1 times every 6 seconds	Battery Failure Error	The battery did not last enough for a manual or monthly test	Replace the batteries
		The battery did not last enough for an annual test	Replace the batteries
		Battery fail in charge	Replace the batteries
 LED Flashing RED 2 times every 6 seconds	Charger Failure Error	Charger not working	Reset the unit (see page 4) and if the same error is displayed, replace the charger board
 LED Flashing RED 3 times every 6 seconds	Lamp Failure Error	Lost 10% or more if initial lamp loading is lost	Replace the bad lamp and reset the unit
	-Lamp Failure Error -No output voltage	The fuses are burnt	Replace the fuses after verifying that there is no short circuit in the load
		Loose connection to the terminal block	Verify that all wires are well connected to the terminal block
 LED AMBER (ORANGE) steady On	Network server down	The Nexus modem is no longer sending a signal to the Nexus server.	See Nexus manual system
 LED flashing between AMBER/OFF	Wink mode	The unit is in yellow blink mode	Stop the wink mode by sending a message from the Nexus server or reset the unit (see page 4).

CONTACT CUSTOMER SERVICE FOR REPLACEMENT PARTS.
SERVICING MUST BE PERFORMED BY QUALIFIED PERSONNEL.
Consult Customer Service for current warranty information.

All information and specifications contained in these instructions are subject to change
due to engineer design, errors and omissions.
© 2014 Thomas & Betts Limited. All rights reserved