

# Wire Guards

## CATALOG NUMBER WG1-L

### APPLICATION

#### Exit Signs (Wall Mount)

GX, GXE Series (6" only)  
 XD, XDN Series  
 TX, TXE Series  
 UX4 Series, GRANDE™ Exit Series  
 QLX500, QLXN500 Series  
 XT Series

#### Battery Units

Grande™ Battery Unit (Wall Mount);  
 MC Series (ELF3, DR1130 Heads);

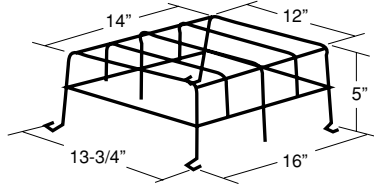

## CATALOG NUMBER WG5-L

### APPLICATION

#### Exit Signs (Ceiling & End Mount)

GX, GXE Series (6" only)  
 XD, XDN Series  
 TX, TXE Series  
 UX4 Series,  
 GRANDE™ Exit Series  
 QLX500, QLXN500 Series  
 XT Series

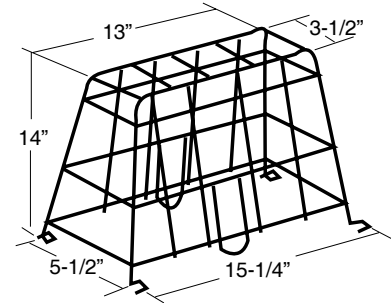

## CATALOG NUMBER WG2-L

### APPLICATION

#### Exit Signs

Grande™ (Combination Unit, Wall Mount)

#### Battery Units

MC Series (ELF 645 & ELF623 Heads);  
 PG & P12G Series;  
 PN & P12N Series (A Cabinet)

#### Remote Fixtures

DR 3130

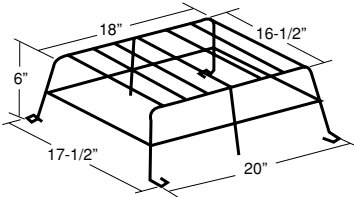

## CATALOG NUMBER WG6-L

### APPLICATION

#### Exit Signs

UX4 (Combination Unit Wall Mount);  
 QLXN2MRS (Combination Unit Wall Mount)

#### Battery Units

RD Series

#### Remote Fixtures

ELF647C, ELF647DC

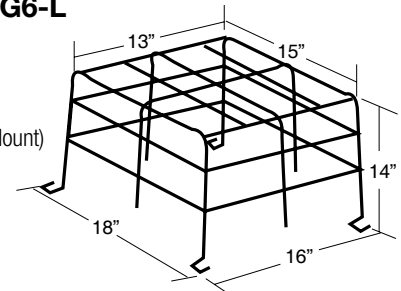

## CATALOG NUMBER WG3-L

### APPLICATION

#### Battery Units

PN & P12N Series (B Cabinet);  
 PQ & P12Q Series;  
 S12E4 Series  
 FG Series

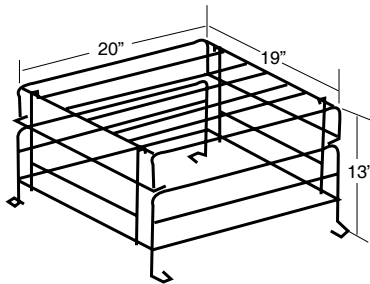

## CATALOG NUMBER WG8-L

### APPLICATION

#### Remote Fixtures

DR1130, DR 2130;  
 ELF623, ELF623D  
 ELF2, ELF2D, ELF2T  
 ELF3, ELF3D, ELF3T  
 ELF648, ELF648D

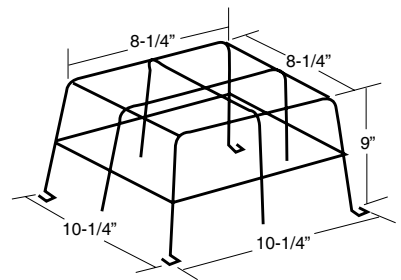

## CATALOG NUMBER WG4-L

### APPLICATION

#### Exit Signs

QLXN2SQ (Combination Unit, Wall Mount)

#### Battery Units

S12E5, S12E6 & S24E4 Series

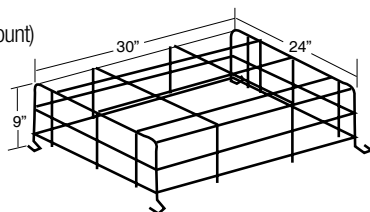

Designed to increase the protection level and deter vandalism to Exit signs, Battery units and remote fixtures

### CATALOG NUMBER WG9-L

#### APPLICATION

##### Remote Fixtures

ELF645, ELF645D, ELF645T;  
ELF647, ELF647D, ELF647T

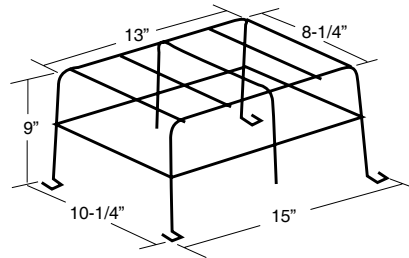

### CATALOG NUMBER WG13-L

#### APPLICATION

##### Exit Signs (Wall Mount)

GX, GXE Series (6" only);  
XD, XDN Series;  
XL Series;  
TX, TXE Series;  
UX4 Series,  
GRANDE™ Exit Series;  
QLX500, QLXN500 Series;  
XT Series

##### Battery Units

LCA-2MRS Series, LCA-2LD Series, LCA1250 Series

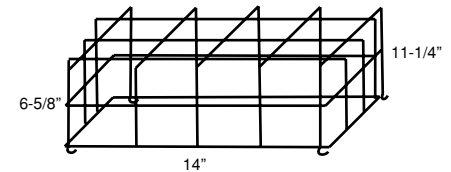

### CATALOG NUMBER WG10-L

#### APPLICATION

##### Battery Units

LCA-2 SQ Series;  
LCA-2 MRS Series;

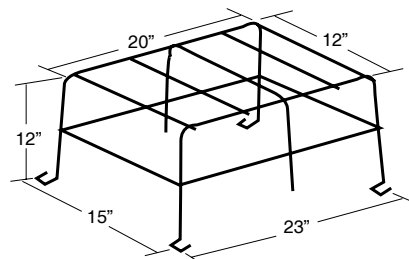

### CATALOG NUMBER WG14-L

#### APPLICATION

##### Exit Signs (Ceiling Mount)

GX, GXE Series (6" & 8");  
XD, XDN Series;  
TX, TXE Series;  
UX4 Series,  
GRANDE™ Exit Series;  
QLX500, QLXN500 Series

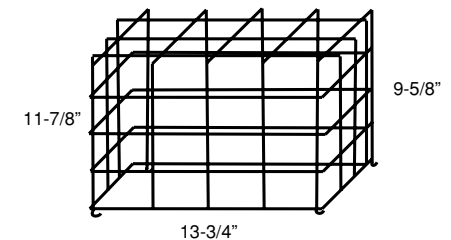

### CATALOG NUMBER WG11-L

#### APPLICATION

##### Exit Signs (Wall Mount)

Floor proximity Recessed Exit  
TX, TXE Series

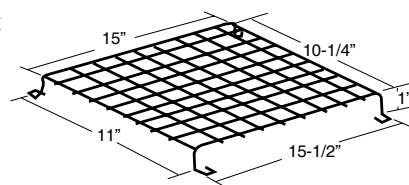

### CATALOG NUMBER WG15-L

#### APPLICATION

##### Exit Signs (Wall Mount)

GX, GXE Series (6" & 8");  
XD, XDN Series  
TX, TXE Series  
UX4 Series,  
GRANDE™ Exit Series  
QLX500, QLXN500 Series

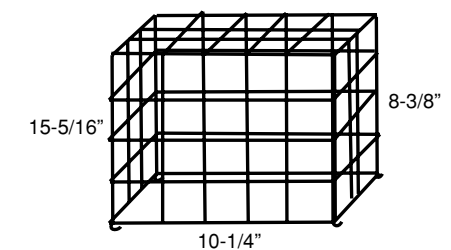

### CATALOG NUMBER WG12-L

#### APPLICATION

##### Exit Signs (Wall Mount)

XD, XDN Series  
TX, TXE Series  
UX4 Series,  
GRANDE™ Exit Series  
QLX500, QLXN500 Series  
XT Series

